

LED WATTAGE CHART

	16L
400 milliamps	21w
530 milliamps	25w
700 milliamps	33w

The Westfield LED Bollard is a combination of security, style and vandal resistance that blends beautifully into any walkway environment.

LED wattage ranges from 21 to 33 by using 16 LEDs with Opal standard lens. The Westfield Bollard casts a beautiful combination of uniform direct and indirect illumination that will enhance any marine, retail, or residential upscale project.

The patent pending Star Power™ optical system is made of diffused 95% reflective low-glare optic material. Its performance exceeds IES minimum foot candle levels at lower wattage and extends maintenance cycles throughout its lifetime.

Built to conform to the strictest Made in America standards. Designed, tooled, fabricated and assembled in the USA.

BUY AMERICAN

To ensure the latest BAA/TAA/BABA Standards are being met, please select BAA, TAA, or BABA in the options section. Please contact the factory before placing an order for any NLS products requesting BAA (Buy American Act), TAA (Trade American Act), or BABA (Build America, Buy America).

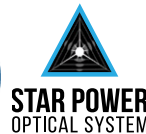

STAR POWER™ OPTICAL SYSTEM

The Star Power™ reflector is an excellent system which provides great value and performance. Star Power Patent number: 10168023

Project Name:

Type:

WESTFIELD BOLLARD ORDERING GUIDE

Cat#	Height	Light Dist.	# of LEDs	Miliamps	Kelvin
Westfield - 1 (WFB-1)	42" (42)	Type 5 (T5)	16 (16L)	400 (40)	Amber 585-600nM (AMBER) ^{4, 6, 7}
				530 (53)	Amber LED Phosphor Converted (AMBER/PC) ^{6, 7}
				700 (7)	2700K, 70 CRI (27K7)
					2700K, 80 CRI (27K8) ¹
					3000K, 70 CRI (30K7)
					3000K, 80 CRI (30K8) ¹
					3500K, 80 CRI (35K8) ¹
					4000K, 70 CRI (40K7)
					4000K, 80 CRI (40K8) ¹
					5000K, 70 CRI (50K7)
	5000K, 80 CRI (50K8) ¹				

Volts	Mounting	Color	Options
120-277 (UNV)	Anchor Base (AB)	Bronze Textured (BRZ)	Button Photocell (PC) ²
347-480 (HV)		White Textured (WHT)	Marine Grade Finish (MGF)
		Smooth White Gloss (SWT)	Emergency Battery Back-Up 4 W (EM4) ²
		Silver Metallic (SVR)	Emergency Battery Back-Up 8 W (EM8) ²
		Black Textured (BLK)	House Side Shield (HSS)
		Smooth Black Gloss (SBK)	Buy American Act (BAA) ⁵
		Graphite Textured (GPH)	Trade Agreement Act (TAA) ⁵
		Grey Textured (GRY)	Build America Buy American (BABA) ⁵
		Green Textured (GRN)	Custom Controls Integration (CCI) ³
		Hunter Green Textured (HGN)	Clear Lens (CL)
	Custom (CS)	Integral GFCI Outlet (GFCI) ^{8, 9}	
		USB Charging Outlet (USB) ^{8, 10}	

NOTES:

1. Consult Factory for Lead Time. Consult Factory for 90 CRI Requests.
2. Universal Voltage 120-277
3. Please contact Factory for Custom Control Integration requests (nLight, NX, WaveLinx, Crestron, DMX/RDM, Synapse, Casambi, Dali II, Avi-On, or other control systems)
4. Turtle Safe
5. Consult factory for all BAA/TAA/BABA requests
6. Consult Factory for Lead Time
7. Not Available above 530mA
8. 120V Only
9. GFCI installed 12" from base, street side. Contact Factory for custom height
10. USB - Specify location.



701 Kingshill Place, Carson, CA 90746
Call Us Today (310) 341-2037

nlsighting.com

PRODUCT SPECIFICATIONS

ELECTRICAL

- 120-277 Volts (UNV) or 347-480 Volts (HV)
- 0-10V dimming driver
- Driver power factor at maximum load is $\geq .95$, THD maximum load is 15%
- LED Drivers Ambient Temp. Min is -40°C and Ambient Temp. Max ranges from 50°C to 55°C and, in some cases, even higher. Consult the factory for revalidation by providing the fixture catalog string before quoting and specifying it.
- All internal wiring UL certified for 600 VAC and 105°C
- CRI 70, 80 or 90
- Color temperatures: Amber, 2700, 3000K, 3500K, 4000K, 5000K
- Surge Protection: 20kA supplied as standard.

CONSTRUCTION

- Extruded Aluminum. Cast Aluminum.

OPTIONS

- MARINE GRADE FINISH (MGF) - A multi-step process creating protective finishing coat against harsh environments. Chemically washed in a 5 stage cleaning system. Pre-baked, Powder coated 3-5 mils of Zinc Rich Super Durable Polyester Primer. Oven Baked. Finished Powder Coating of Super Durable Polyester Powder Coat 3-5 mil thickness.
- VANDAL RESISTANT BASE (VRB)
- CLEAR LENS (CL)
- 20kA Surge Protector (20K)
- Integral GFCI Outlet (GFCI)
- USB Charging Outlet (USB)
- EMERGENCY BATTERY BACK-UP (EB)
 - 100-277 VAC $\pm 10\%$, 50/60 Hz Input Voltage
 - 43mA Max. Input Current
 - 2.82W Max. Input Power
 - 24-48 Hours Recharge Time
 - Battery Type NiCd 9.6VDC or LiFePO4 9.6VDC
 - 90 Minutes Min. Illumination Time
 - 20W Total Max. LED Powered
 - Class 2 Output Classification

CONTROL OPTIONS

- PHOTOCELL (PC) - Button Type
- Controls Agnostic: Please contact factory for your preferred controls option. (nLight, NX, WaveLinx, Crestron, DMX/RDM, Synapse, Casambi, DALI II, Avi-On, or other control systems)

OPTICS

Recessed Star Power Optical System is 95% reflective material. Utilizes a linear diffused pattern, softening the light distribution and eliminating any dark shadows or striations.

- IES Types

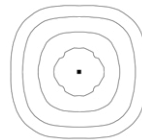

TYPE V (T5)

FINISH

- 3-5 mils electrostatic powder coat.
- NLS Lighting standard high-quality finishes prevent corrosion and protects against extreme environmental conditions
- 10 Standard Finishes, Custom Finish and Marine Grade Finish Available

WARRANTY

Five-year limited warranty for drivers and LEDs.

BUY AMERICAN OPTION

While all of the NLS Lighting products listed in this document qualify for the Buy America(n) Act of 1933, we reserve the right to change our listings without notice.

The information provided above is for general informational purposes only. We encourage you to consult legal professionals for advice particular to your projects concerning BAA, TAA, BABA or Buy America.

Additional NLS Products that meet BAA, TAA standards can be found at the following link:

<https://nslighting.com/buy-american/>



The information and specifications on this document are subject to change without any notification. All values are design, nominal, or typical or prorated values when measured under internal and external laboratory conditions.



701 Kingshill Place, Carson, CA 90746
Call Us Today (310) 341-2037

nslighting.com

PRODUCT SPECIFICATIONS

WEIGHT	WFB-1
SINGLE	25 LBS

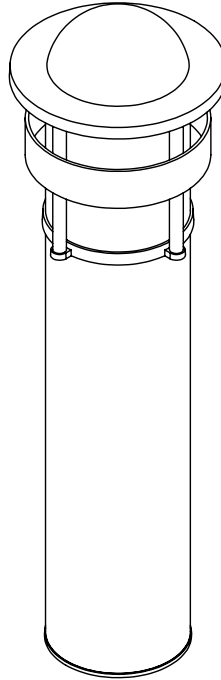
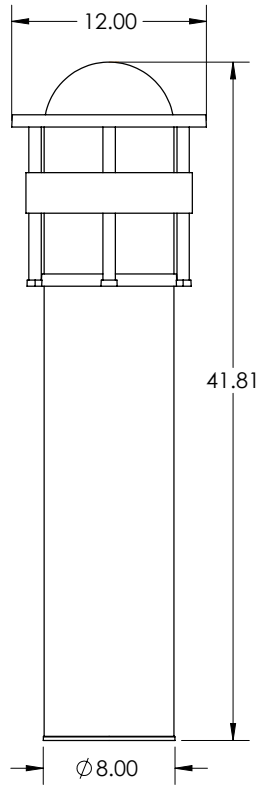

Vandal Resistant Base
(Optional)

PRODUCT SPECIFICATIONS

LED KELVIN RANGE

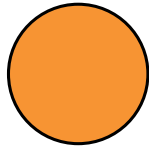

AMBER
585-600 nm

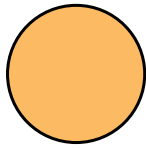

2700K 70 CRI

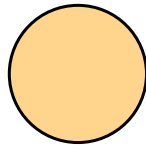

3000K 70 CRI

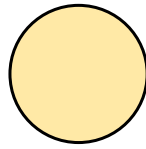

3500K 80 CRI

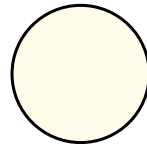

4000K 70 CRI

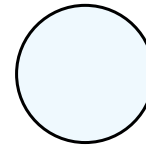

5000K 70 CRI

Color	Dominant or Peak Wavelength Range (nm)	
	Minimum	Maximum
Amber	585	600

LUMEN MAINTENANCE DATA							
Ambient Temperature	Drive Current	L90 Hours*	L70 Hours**	30,000 Hours*	50,000 Hours*	60,000 Hours*	100,000 Hours**
25°C	Up to 700mA	58,000	173,000	95.7%	91.6%	89.6%	82.1%
*Reported extrapolations per IESNA TM-21				**Projected extrapolations per IESNA TM-21			

WESTFIELD BOLLARD - LUMEN DATA CHART			
PART NUMBER	T5 LUMENS	Lm/W	WATTS
WFB-1-16L-40-27K7	1127	54	21
WFB-1-16L-40-27K8	1056	50	21
WFB-1-16L-40-30K8	1132	54	21
WFB-1-16L-40-30K7	1219	58	21
WFB-1-16L-40-35K8	1132	54	21
WFB-1-16L-40-40K8	1219	58	21
WFB-1-16L-40-40K7	1317	63	21
WFB-1-16L-40-50K8	1219	58	21
WFB-1-16L-40-50K7	1317	63	21
WFB-1-42-16L-53-30K	1400	56	25
WFB-1-42-16L-53-40K	1500	60	25
WFB-1-42-16L-53-50K	1600	64	25
WFB-1-42-16L-7-30K	1848	56	33
WFB-1-42-16L-7-40K	1980	60	33
WFB-1-42-16L-7-50K	2112	64	33

PRODUCT SPECIFICATIONS

MARINE GRADE FINISH (MGF)

The **(MGF)** is a multi step process. Chemically washed in a 5 stage cleaning system. Pre-baked. Powder coated 3-5 mil of Zinc Rich Super Durable Polyester Primer. Oven Baked. Finished Powder Coating of Super Durable Polyester Powder Coat 3-5 mil thickness.



BUTTON TYPE PHOTOCELL (PC)

Photocell for dusk to dawn operation.
Consult Factory.

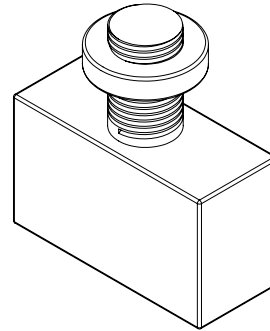

WITHOUT LEVELING NUT DIAGRAM

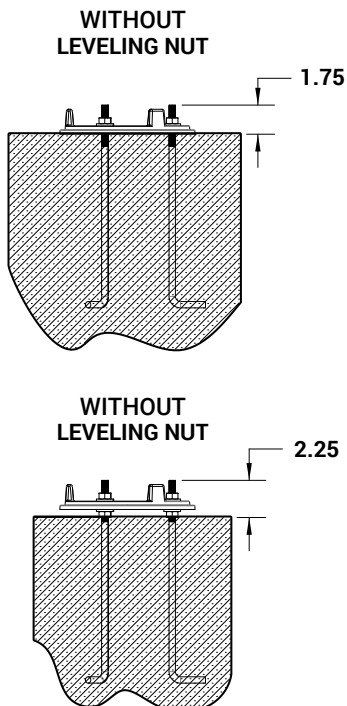

BOLT CIRCLE

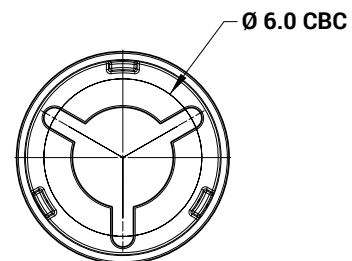

PRODUCT SPECIFICATIONS

SHIELDING OPTIONS (HSS)

SHIELDS (HSS)—House Side Shield (HSS) is designed for full property line cut-off.

HOUSE SIDE SHIELD

