

LED WATTAGE CHART

	16L
400 milliamps	21w
530 milliamps	26w
700 milliamps	36w

The Sea Side Concrete Bollard is a combination of security, style and vandal resistance that blends beautifully into any pathway environment.

This luminaire tower can disperse light in a 45° angle with the cast Cut Off Grill (COG45) with diffused lens standard. Paraline Reflector (PR) or Stacked Louver (SL) are optional light distributions with a clear lens standard.

LED wattage ranges from 21 to 36 using 16 LEDs. The 8" round Sea Side Concrete Bollard is available with the Dome Top or Flat Top in concrete or aluminum. The 8" square Sea Side Concrete Bollard comes with a Flat Top or Pyramid top option in concrete or Flat Top in aluminum.

Kelvin temperature offerings of Amber, 2700, 3000K, 3500K, 4000K, and 5000K.

BUY AMERICAN

To ensure the latest BAA/TAA/BABA Standards are being met, please select BAA, TAA, or BABA in the options section. Please contact the factory before placing an order for any NLS products requesting BAA (Buy American Act), TAA (Trade American Act), or BABA (Build America, Buy America).



Project Name:

Type:

SEA SIDE CONCRETE ROUND BOLLARD ORDERING GUIDE

Cat#	Height	Shaft Dim.	Light Dist.	# of LEDs	Milliamps	Kelvin
Sea Side Concrete Shaft & Dome Top (SSCCD) ②	37" (37) 43" (43) 49" (49)	8" Round (8R)	Cut Off Grill (COG45)	16 (16L)	400 (40) 530 (53) 700 (7)	Amber 585-600nm (AMBER) ③④⑤ 2700K, 70 CRI (27K7) 2700K, 80 CRI (27K8) ⑥ 3000K, 70 CRI (30K7) 3000K, 80 CRI (30K8) ⑥ 3500K, 80 CRI (35K8) ⑥ 4000K, 70 CRI (40K7) 4000K, 80 CRI (40K8) ⑥ 5000K, 70 CRI (50K7) 5000K, 80 CRI (50K8) ⑥
Sea Side Concrete Shaft & Flat Top (SSCCF)	36.25" (36) 42.25" (42) 48.25" (48)					
Sea Side Concrete Metal Dome Top (SSCMD)	37.25" (37) 43.25" (43) 49.25" (49)		Cut Off Grill (COG45)			
Sea Side Concrete Metal Flat Top (SSCMF) ②	36.25" (36) 42.25" (42) 48.25" (48)		Stacked Louver (SL) Paracline Reflector (PR)			

Voltage	Anchor Base	Concrete Texture	Concrete Color	Metal Color	Options
120-277 (UNV) 347-480 (HV)	Anchor Base (AB) ⑦	Light Sandblast (LSB) Medium Sandblast (MSB) Heavy Sandblast (HSB) Exposed Aggregate (EAG) Custom Concrete Texture (CCT) ⑩	Natural (NA) Graystone (GS) Smoke Gray (SG) Slate (SL) Ebony (EB) White (WH) Honey Beige (HB) Almond Beige (AB) Tuscan Sand (TS) Cobble Brown (CB) Coffee (CO) Prairie Red (PR) Brick Red (BR) Custom Concrete Color (CC)	Bronze Textured (BRZ) White Textured (WHT) Smooth White Gloss (SWT) Silver Metallic (SVR) Black Textured (BLK) Smooth Black Gloss (SBK) Graphite Textured (GPH) Grey Textured (GRY) Green Textured (GRN) Hunter Green Textured (HGN) Custom Aluminum Top/Louver Color (CLC)	Marine Grade Finish (MGF) ⑧ Emergency Battery Back-Up 4w (EM4) ⑨ Emergency Battery Back-Up 8w (EM8) ⑨ House Side Shield (HSS) Buy American (BAA) ⑧ Trade Agreement Act (TAA) ⑧ Build America Buy American (BABA) ⑧ Custom Controls Integration (CCI) ⑧ Integral GFCI Outlet (GFCI) ⑧ USB Charging Outlet (USB) ⑧ Logo (LOGO) ⑧ Button Photocell (PC)

Notes:

- ① Consult Factory for Lead Time. Consult Factory for 90 CRI Requests.
- ② Dome Top for Round Shaft Only
- ③ Universal Voltage 120-277
- ④ Please contact Factory for Custom Control Integration requests (nLight, NX, WaveLinx, Crestron, DMX/RDM, Synapse, Casambi, Dali II, Avi-On, or other control systems)
- ⑤ Turtle Safe
- ⑥ Consult factory for all BAA/TAA/BABA requests
- ⑦ Contact Factory
- ⑧ For Metal parts only
- ⑨ Consult Factory for Lead Time
- ⑩ Consult Factory, requires customer sample

Project Name:

Type:

SEA SIDE CONCRETE SQUARE BOLLARD ORDERING GUIDE

Cat#	Height	Shaft Dim.	Light Dist.	# of LEDs	Milliamps	Kelvin
Sea Side Concrete Pyramid Top (SSCCP)	38.5" (39)	8" Square (8S)	Cut Off Grill (COG45)	16 (16L)	400 (40)	Amber 585-600nm (AMBER) ⑥⑦⑩
	44.5" (45)				530 (53)	
	50.5" (51)				700 (7)	
Sea Side Concrete Flat Top (SSCCF)	37.5" (38)					2700K, 70 CRI (27K7)
	43.5" (44)					2700K, 80 CRI (27K8) ⑥
	49.5" (50)					3000K, 70 CRI (30K7)
						3000K, 80 CRI (30K8) ⑥
Sea Side Concrete Metal Flat Top (SSCMF)	37.25" (37)		Cut Off Grill (COG45)			3500K, 80 CRI (35K8) ⑥
	43.25" (43)					4000K, 70 CRI (40K7)
	49.25" (49)					4000K, 80 CRI (40K8) ⑥
	35.25" (35)		Stacked Louver (SL)			5000K, 70 CRI (50K7)
	41.25" (41)		Paracline Reflector (PR)			5000K, 80 CRI (50K8) ⑥
	47.25" (47)					

Voltage	Anchor Base	Concrete Texture	Concrete Color	Metal Color	Options
120-277 (UNV)	Anchor Base (AB) ⑥	Light Sandblast (LSB)	Natural (NA)	Bronze Textured (BRZ)	Marine Grade Finish (MGF) ⑥
347-480 (HV)		Medium Sandblast (MSB)	Graystone (GS)	White Textured (WHT)	Emergency Battery Back-Up 4w (EM4) ⑥
		Heavy Sandblast (HSB)	Smoke Gray (SG)	Smooth White Gloss (SWT)	Emergency Battery Back-Up 8w (EM8) ⑥
		Exposed Aggregate (EAG)	Slate (SL)	Silver Metallic (SVR)	House Side Shield (HSS)
		Custom Concrete Texture (CCT) ⑩	Ebony (EB)	Black Textured (BLK)	Buy American (BAA) ⑥
			White (WH)	Smooth Black Gloss (SBK)	Trade Agreement Act (TAA) ⑥
			Honey Beige (HB)	Graphite Textured (GPH)	Build America Buy American (BABA) ⑥
			Almond Beige (AB)	Grey Textured (GRY)	Custom Controls Integration (CCI) ④
			Tuscan Sand (TS)	Green Textured (GRN)	Integral GFCI Outlet (GFCI) ⑦
			Cobble Brown (CB)	Hunter Green Textured (HGN)	USB Charging Outlet (USB) ⑦
			Coffee (CO)	Custom Aluminum Top/Louver Color (CLC)	Logo (LOGO) ⑦
			Prairie Red (PR)		Button Photocell (PC)
			Brick Red (BR)		
			Custom Concrete Color (CC)		

Notes:

- ① Consult Factory for Lead Time. Consult Factory for 90 CRI Requests.
- ② Dome Top for Round Shaft Only
- ③ Universal Voltage 120-277
- ④ Please contact Factory for Custom Control Integration requests (nLight, NX, WaveLinx, Crestron, DMX/RDM, Synapse, Casambi, Dali II, Avi-On, or other control systems)
- ⑤ Turtle Safe
- ⑥ Consult factory for all BAA/TAA/BABA requests
- ⑦ Contact Factory
- ⑧ For Metal parts only
- ⑨ Consult Factory for Lead Time
- ⑩ Consult Factory, requires customer sample

PRODUCT SPECIFICATIONS

SEA SIDE CONCRETE BOLLARD DIMENSIONS AND CONFIGURATION GUIDE

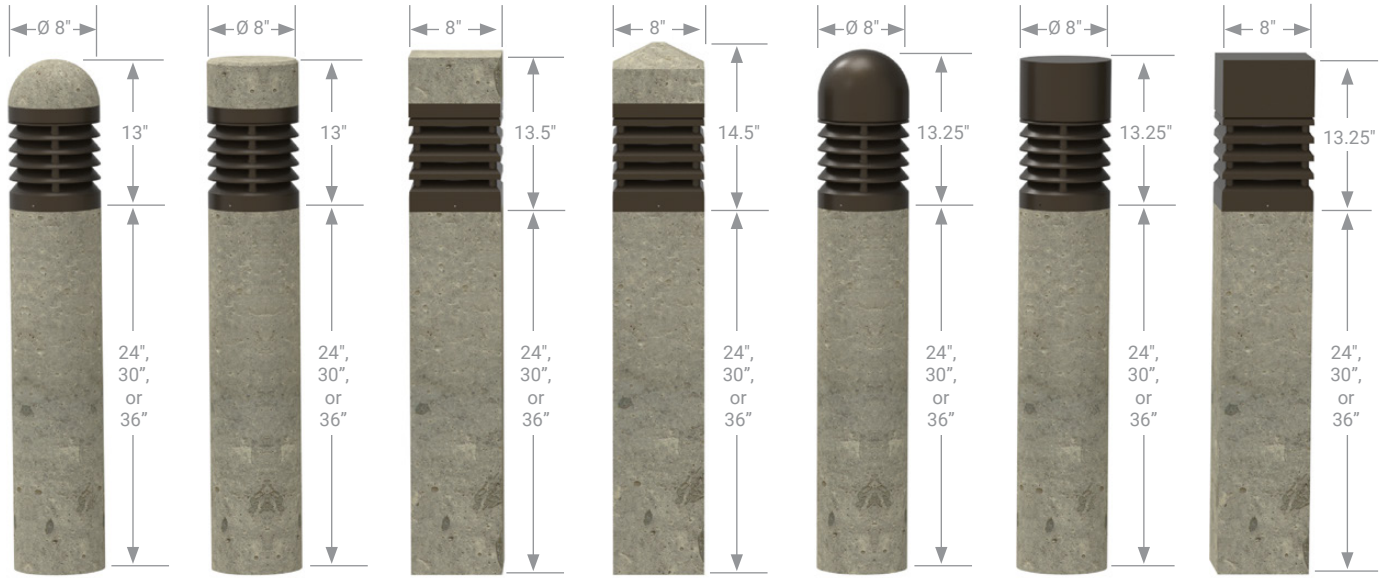

SSCCD-8R-COG45 SSSCF-8R-COG45 SSSCF-8S-COG45 SSSCP-8S-COG45 SSCD-8R-COG45 SSSCF-8R-COG45 SSSCF-8S-COG45

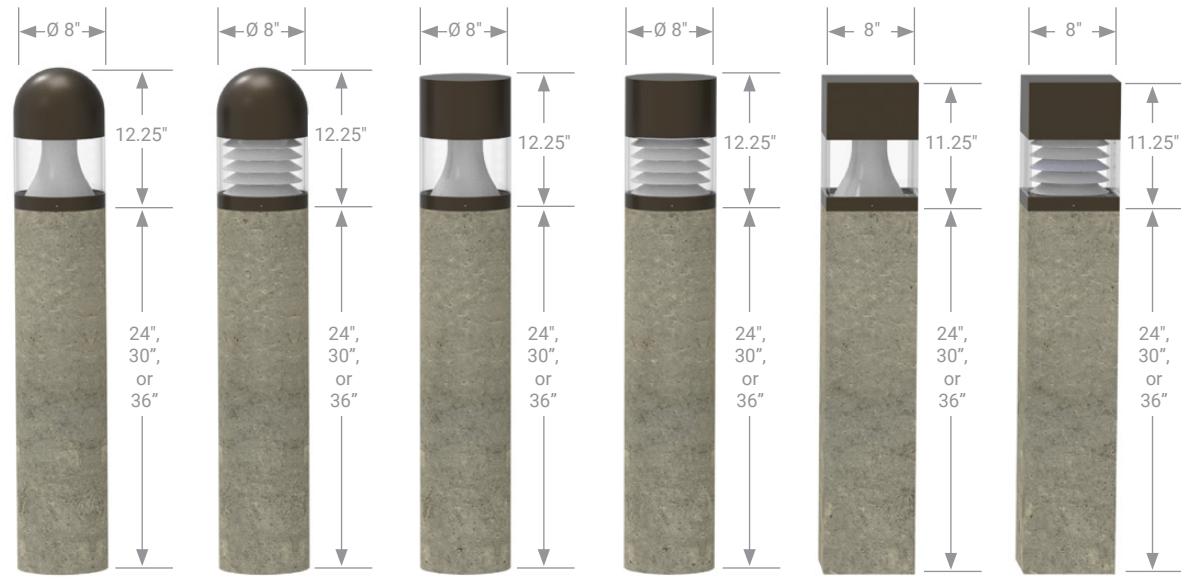

SSCD-8R-PR SSCD-8R-SL SSSCF-8R-PR SSSCF-8R-SL SSSCF-8S-PR SSSCF-8S-SL

	Concrete Shaft		Bollard Top		Light Distribution		
	Round	Square	Concrete	Aluminum	COG45	PR	SL
SSCCD-8R-COG45	X		X		X		
SSCCF-8R-COG45	X		X		X		
SSCCF-8S-COG45		X	X		X		
SSCCP-8S-COG45		X	X		X		
SSCD-8R-COG45	X			X	X		
SSCF-8R-COG45	X			X	X		
SSCF-8S-COG45		X		X	X		
SSCD-8R-PR	X			X		X	
SSCD-8R-SL	X			X			X
SSCF-8R-PR	X			X		X	
SSCF-8R-SL	X			X			X
SSCF-8S-PR		X		X		X	
SSCF-8S-SL		X		X			X

DIMENSION	8" ROUND/SQUARE BOLT CIRCLE
Bolt Circle	Ø 10" MIN B.C. TO Ø 14" MAX B.C.

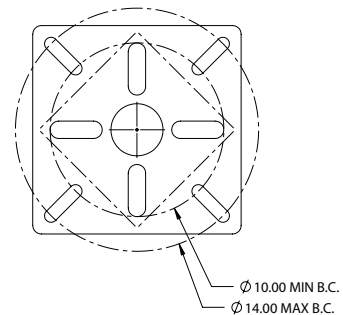

PRODUCT SPECIFICATIONS

SEA SIDE CONCRETE 8" ROUND BOLLARD - DIMENSIONS CHART

CATALOG	DESCRIPTION	TOP (In.)	BODY (In.)	HEIGHT (In.)
SSCCD-37-8R-COG45	37" H, 16 LED, Concrete Dome Top - Cut Off Grill	13.00	24.00	37.00
SSCCD-43-8R-COG45	43" H, 16 LED, Concrete Dome Top - Cut Off Grill	13.00	30.00	43.00
SSCCD-49-8R-COG45	49" H, 16 LED, Concrete Dome Top - Cut Off Grill	13.00	36.00	49.00
SSCCF-37-8R-COG45	37" H, 16 LED, Concrete Flat Top - Cut Off Grill	13.00	24.00	37.00
SSCCF-43-8R-COG45	43" H, 16 LED, Concrete Flat Top - Cut Off Grill	13.00	30.00	43.00
SSCCF-49-8R-COG45	49" H, 16 LED, Concrete Flat Top - Cut Off Grill	13.00	36.00	49.00
SSCCD-36-8R-SL	35.25" H, 16 LED, Concrete Dome Top - Stacked Louver	12.25	24.00	36.25
SSCCD-42-8R-SL	41.25" H, 16 LED, Concrete Dome Top - Stacked Louver	12.25	30.00	42.25
SSCCD-48-8R-SL	47.25" H, 16 LED, Concrete Dome Top - Stacked Louver	12.25	36.00	48.25
SSCCF-36-8R-SL	35.25" H, 16 LED, Concrete Flat Top - Stacked Louver	12.25	24.00	36.25
SSCCF-42-8R-SL	41.25" H, 16 LED, Concrete Flat Top - Stacked Louver	12.25	30.00	42.25
SSCCF-48-8R-SL	47.25" H, 16 LED, Concrete Flat Top - Stacked Louver	12.25	36.00	48.25
SSCCD-36-8R-PR	36.25" H, 16 LED, Concrete Dome Top - Paracline Reflector	12.25	24.00	36.25
SSCCD-42-8R-PR	42.25" H, 16 LED, Concrete Dome Top - Paracline Reflector	12.25	30.00	42.25
SSCCD-48-8R-PR	48.25" H, 16 LED, Concrete Dome Top - Paracline Reflector	12.25	36.00	48.25
SSCCF-36-8R-PR	36.25" H, 16 LED, Concrete Flat Top - Paracline Reflector	12.25	24.00	36.25
SSCCF-42-8R-PR	42.25" H, 16 LED, Concrete Flat Top - Paracline Reflector	12.25	30.00	42.25
SSCCF-48-8R-PR	48.25" H, 16 LED, Concrete Dome Top - Paracline Reflector	12.25	36.00	48.25
SSCMD-37-8R-COG45	37.25" H, 16 LED, Metal Dome Top - Cut Off Grill	13.25	24.00	37.25
SSCMD-43-8R-COG45	43.25" H, 16 LED, Metal Dome Top - Cut Off Grill	13.25	30.00	43.25
SSCMD-49-8R-COG45	49.25" H, 16 LED, Metal Dome Top - Cut Off Grill	13.25	36.00	49.25
SSCMD-36-8R-SL	36.25" H, 16 LED, Metal Dome Top - Stacked Louver	12.25	24.00	36.25
SSCMD-42-8R-SL	42.25" H, 16 LED, Metal Dome Top - Stacked Louver	12.25	30.00	42.25
SSCMD-48-8R-SL	48.25" H, 16 LED, Metal Dome Top - Stacked Louver	12.25	36.00	48.25
SSCMF-36-8R-SL	36.25" H, 16 LED, Metal Flat Top - Stacked Louver	12.25	24.00	36.25
SSCMF-42-8R-SL	42.25" H, 16 LED, Metal Flat Top - Stacked Louver	12.25	30.00	42.25
SSCMF-48-8R-SL	48.25" H, 16 LED, Metal Flat Top - Stacked Louver	12.25	36.00	48.25
SSCMD-36-8R-PR	36.25" H, 16 LED, Metal Dome Top - Paracline Reflector	12.25	24.00	36.25
SSCMD-42-8R-PR	42.25" H, 16 LED, Metal Dome Top - Paracline Reflector	12.25	30.00	42.25
SSCMD-48-8R-PR	48.25" H, 16 LED, Metal Dome Top - Paracline Reflector	12.25	36.00	48.25
SSCMF-36-8R-PR	36.25" H, 16 LED, Metal Flat Top - Paracline Reflector	12.25	24.00	36.25
SSCMF-42-8R-PR	42.25" H, 16 LED, Metal Flat Top - Paracline Reflector	12.25	30.00	42.25
SSCMF-48-8R-PR	48.25" H, 16 LED, Metal Flat Top - Paracline Reflector	12.25	36.00	48.25



701 Kingshill Place, Carson, CA 90746
Call Us Today (310) 341-2037

nlsighting.com

PRODUCT SPECIFICATIONS

SEA SIDE CONCRETE 8" SQUARE BOLLARD - DIMENSIONS CHART

CATALOG	DESCRIPTION	TOP (In.)	BODY (In.)	HEIGHT (In.)
SSCCP-39-8S-COG45	38.5" H, 16 LED, Concrete Pyramid Top - Cut Off Grill	14.50	24.00	38.50
SSCCP-45-8S-COG45	44.5" H, 16 LED, Concrete Pyramid Top - Cut Off Grill	14.50	30.00	44.50
SSCCP-51-8S-COG45	50.5" H, 16 LED, Concrete Pyramid Top - Cut Off Grill	14.50	36.00	50.50
SSCCF-38-8S-COG45	37.5" H, 16 LED, Concrete Flat Top - Cut Off Grill	13.50	24.00	37.50
SSCCF-44-8S-COG45	43.5" H, 16 LED, Concrete Flat Top - Cut Off Grill	13.50	30.00	43.50
SSCCF-50-8S-COG45	49.5" H, 16 LED, Concrete Flat Top - Cut Off Grill	13.50	36.00	49.50
SSCMF-37-8S-COG45	37.25" H, 16 LED, Metal Flat Top - Cut Off Grill	13.25	24.00	37.25
SSCMF-43-8S-COG45	43.25" H, 16 LED, Metal Flat Top - Cut Off Grill	13.25	30.00	43.25
SSCMF-49-8S-COG45	49.25" H, 16 LED, Metal Flat Top - Cut Off Grill	13.25	36.00	49.25
SSCMF-35-8S-SL	35.25" H, 16 LED, Metal Flat Top - Stacked Louver	11.25	24.00	35.25
SSCMF-41-8S-SL	41.25" H, 16 LED, Metal Flat Top - Stacked Louver	11.25	30.00	41.25
SSCMF-47-8S-SL	47.25" H, 16 LED, Metal Flat Top - Stacked Louver	11.25	36.00	47.25
SSCMF-35-8S-PR	35.25" H, 16 LED, Metal Flat Top - Paracline Reflector	11.25	24.00	35.25
SSCMF-41-8S-PR	41.25" H, 16 LED, Metal Flat Top - Paracline Reflector	11.25	30.00	41.25
SSCMF-47-8S-PR	47.25" H, 16 LED, Metal Flat Top - Paracline Reflector	11.25	36.00	47.25

ELECTRICAL

- 120-277 Volts (UNV) or 347-480 Volts (HV)
- 0-10V dimming driver
- Driver power factor at maximum load is ≥ .95, THD maximum load is 15%
- LED Drivers Ambient Temp. Min is -40°C and Ambient Temp. Max ranges from 50°C to 55°C. Consult the factory for revalidation by providing the fixture catalog string before quoting and specifying it.
- All internal wiring UL certified for 600 VAC and 105°C
- CRI 70, 80 or 90
- Color temperatures: Amber, 2700, 3000K, 3500K, 4000K, 5000K
- Surge Protection: 20kA supplied as standard.

CONSTRUCTION

- Extruded Aluminum. Cast Aluminum. Spun Aluminum
- Cast Concrete

OPTIONS

• MARINE GRADE FINISH (MGF) - A multi-step process creating protective finishing coat against harsh environments. Chemically washed in a 5 stage cleaning system. Pre-baked, Powder coated 3-5 mils of Zinc Rich Super Durable Polyester Primer. Oven Baked. Finished Powder Coating of Super Durable Polyester Powder Coat 3-5 mil thickness.

- VANDAL RESISTANT BASE (VRB)
- HOUSE SIDE SHIELD (HSS)
- INTEGRAL GFCI OUTLET (GFCI)
- USB CHARGING OUTLET (USB)

CONTROL OPTIONS

- PHOTOCELL (PC) - Button Type
- Controls Agnostic: Please contact factory for your preferred controls option. (nLight, NX, Wavelinx, Crestron, DMX/RDM, Synapse, Casambi, DALI II, Avi-On, or other control systems)

FINISH

- 3-5 mil electrostatic powder coat.
- NLS Lighting standard high-quality finishes prevent corrosion and protects against extreme environmental conditions
- Concrete Texture & Color selections

WARRANTY

Five-year limited warranty for drivers and LEDs.

BUY AMERICAN OPTION

While all of the NLS Lighting products listed in this document qualify for the Buy America(n) Act of 1933, we reserve the right to change our listings without notice.

The information provided above is for general informational purposes only. We encourage you to consult legal professionals for advice particular to your projects concerning BAA, TAA, BABA or Buy America.

Additional NLS Products that meet BAA, TAA standards can be found at the following link:

<https://nslighting.com/buy-american/>



The information and specifications on this document are subject to change without any notification. All values are design, nominal, typical or prorated values when measured under internal and external laboratory conditions.



701 Kingshill Place, Carson, CA 90746
Call Us Today (310) 341-2037

nslighting.com

PRODUCT SPECIFICATIONS

SEA SIDE CONCRETE BOLLARD - LUMEN DATA CHART

PART NUMBER	T5 LUMENS	T5 Lm/W	WATTS	PART NUMBER	T5 LUMENS	T5 Lm/W	WATTS	PART NUMBER	T5 LUMENS	T5 Lm/W	WATTS
SEA SIDE-COG45-16L-40-27K7	987	47	21	SEA SIDE-SL-16L-40-27K7	1081	51	21	SEA SIDE-PR-16L-40-27K7	1397	67	21
SEA SIDE-COG45-16L-40-27K8	924	44	21	SEA SIDE-SL-16L-40-27K8	1012	48	21	SEA SIDE-PR-16L-40-27K8	1308	62	21
SEA SIDE-COG45-16L-40-30K8	991	47	21	SEA SIDE-SL-16L-40-30K8	1085	52	21	SEA SIDE-PR-16L-40-30K8	1402	67	21
SEA SIDE-COG45-16L-40-30K7	1067	51	21	SEA SIDE-SL-16L-40-30K7	1169	56	21	SEA SIDE-PR-16L-40-30K7	1510	72	21
SEA SIDE-COG45-16L-40-35K8	991	47	21	SEA SIDE-SL-16L-40-35K8	1085	52	21	SEA SIDE-PR-16L-40-35K8	1402	67	21
SEA SIDE-COG45-16L-40-40K8	1067	51	21	SEA SIDE-SL-16L-40-40K8	1169	56	21	SEA SIDE-PR-16L-40-40K8	1510	72	21
SEA SIDE-COG45-16L-40-40K7	1153	55	21	SEA SIDE-SL-16L-40-40K7	1263	60	21	SEA SIDE-PR-16L-40-40K7	1632	78	21
SEA SIDE-COG45-16L-40-50K8	1067	51	21	SEA SIDE-SL-16L-40-50K8	1169	56	21	SEA SIDE-PR-16L-40-50K8	1510	72	21
SEA SIDE-COG45-16L-40-50K7	1153	55	21	SEA SIDE-SL-16L-40-50K7	1263	60	21	SEA SIDE-PR-16L-40-50K7	1632	78	21
SEA SIDE-COG45-16L-53-30K	1429	55	26	SEA SIDE-SL-16L-53-30K	1508	58	26	SEA SIDE-PR-16L-53-30K	2002	77	26
SEA SIDE-COG45-16L-53-40K	1502	58	26	SEA SIDE-SL-16L-53-40K	1612	62	26	SEA SIDE-PR-16L-53-40K	2106	81	26
SEA SIDE-COG45-16L-53-50K	1502	58	26	SEA SIDE-SL-16L-53-50K	1690	65	26	SEA SIDE-PR-16L-53-50K	2184	84	26
SEA SIDE-COG45-16L-7-30K	1906	53	36	SEA SIDE-SL-16L-7-30K	2030	58	36	SEA SIDE-PR-16L-7-30K	2695	77	36
SEA SIDE-COG45-16L-7-40K	2003	56	36	SEA SIDE-SL-16L-7-40K	2170	62	36	SEA SIDE-PR-16L-7-40K	2835	81	36
SEA SIDE-COG45-16L-7-50K	2003	56	36	SEA SIDE-SL-16L-7-50K	2275	65	36	SEA SIDE-PR-16L-7-50K	2975	85	36

LUMEN MAINTENANCE DATA

Ambient Temperature	Drive Current	L90 Hours*	L70 Hours**	30,000 Hours*	50,000 Hours*	60,000 Hours*	100,000 Hours**
25°C	Up to 700mA	58,000	173,000	95.7%	91.6%	89.6%	82.1%

*Reported extrapolations per IESNA TM-21 **Projected extrapolations per IESNA TM-21

LED KELVIN RANGE

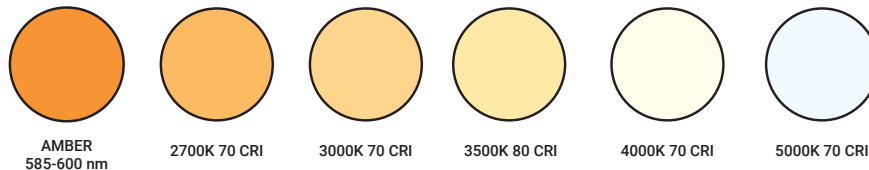

Color	Dominant or Peak Wavelength Range (nm)	
	Minimum	Maximum
Amber	585	600

PRODUCT SPECIFICATIONS

OPTIONS

MARINE GRADE FINISH (MGF)

The **(MGF)** is a multi step process. Chemically washed in a 5 stage cleaning system. Pre-baked. Powder coated 3-5 mil of Zinc Rich Super Durable Polyester Primer. Oven Baked. Finished Powder Coating of Super Durable Polyester Powder Coat 3-5 mil thickness.



Powder Coat Finish
3-5 mil Powder Coat

Primer Layer
3-5 mil Zinc Rich
Super Durable Polyester Primer

Prepared Casting
Chemically washed in multi Step 5 stage
cleaning process

CUSTOM LOGOS (LOGO)

Consult Factory for feasibility and estimated cost



PRODUCT SPECIFICATIONS

STANDARD CONCRETE COLORS



Natural
(NA)



Graystone
(GS)



Smoke Gray
(SG)



Slate
(SL)



Ebony
(EB)



White
(WH)



Honey Beige
(HB)



Almond Beige
(AB)



Tuscan Sand
(TS)

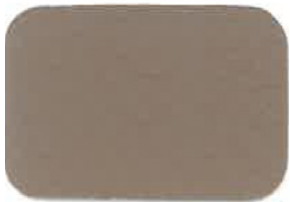

Cobble Brown
(CB)



Coffee
(CO)



Prairie Red
(PR)



Brick Red
(BR)

STANDARD CONCRETE TEXTURE OPTIONS

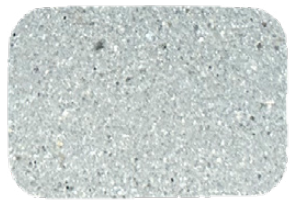

Light Sandblast
(LSB)



Medium Sandblast
(MSB)

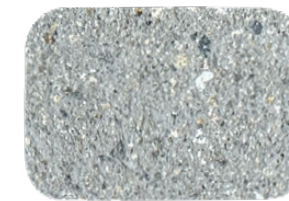

Heavy Sandblast
(HSB)



Exposed Aggregate
(EAG)