



LED WATTAGE CHART

Drive Current	144L
700 milliamps	310W (29287-37332 Lumens)
800 milliamps	355W (33471-42666 Lumens)
900 milliamps	400W (37655-47999 Lumens)
1000 milliamps	445W (41836-53332 Lumens)

FORM

- Elegant Die-Cast Aluminum Housing
- Corrosion Resistant Stainless Steel External Hardware
- Sleek, Low Profile Housing
- Spec Grade Performance
- Engineered For Optimum Thermal Management
- 9 Architectural Finishes Standard, RAL Colors Available

FUNCTION

- Micro Optics IES Distributions 15°, 30°, 55°, 85°, T2, T3, T4, T5
- 0-10V Dimming Drivers
THD @ Max Load < 15%
Power factor @ Max Load < 0.95
- Amber, 2700K, 3000K, 3500K, 4000K, or 5000K
- 144L LED Configuration
- CRI 70, 80, or 90
- 5 MILS Powder Coat

RELIABILITY

- Silicone Micro Optics
- 5 Year Standard Warranty
- IP67 Optics
- IP66 Fixture

BUY AMERICAN

To ensure the latest BAA/TAA/BABA Standards are being met, please select BAA, TAA, or BABA in the options section. Please contact the factory before placing an order for any NLS products requesting BAA (Buy American Act), TAA (Trade American Act), or BABA (Build America, Buy America).



Project Name:

Type:

ORGANIX - F3 - ORDERING GUIDE

Cat#	Optics	Watts	Kelvin Temp		Volts
Organix - Flood (ORX-F3)	15° Very Narrow (15)Ⓢ	310 Watts 144L (310W)	2700K, 70 CRI (27K7)	Red 624-634nm (RED)Ⓢ	120-277 (UNV)
	30° Narrow Beam (30)Ⓢ	355 Watts 144L (355W)	2700K, 80 CRI (27K8)Ⓢ	Amber 585-600nm (AMBER)ⓈⓈⓈ	347-480 (HV)
	55° Medium Beam (55)	400 Watts 144L (400W)	3000K, 70 CRI (30K7)	Green 520-540nm (GREEN)Ⓢ	
	85° Wide Beam (85)	445 Watts 144L (445W)	3000K, 80 CRI (30K8)Ⓢ	Royal Blue 440-460nm (BLUE)Ⓢ	
	IES T2 / NEMA 7Hx5V (T2)Ⓢ		3500K, 80 CRI (35K8)		
	IES T3 / NEMA 7Hx6V (T3)Ⓢ		4000K, 70 CRI (40K7)		
	Forward Throw (T4)Ⓢ		4000K, 80 CRI (40K8)Ⓢ		
	Symmetrical (T5)		5000K, 70 CRI (50K7)		
			5000K, 80 CRI (50K8)Ⓢ		

Mounting	Glare Control Options	Color	Control Options	Options
Knuckle Mount 2.3/8" (KM)	Visor Accessory (VR)	Bronze Textured (BRZ)	Custom Controls Integration (CCI)Ⓢ	Tamper Proof Hardware (TPH)
Wall Mount (WM)Ⓢ	House Side Shield (HSS)Ⓢ	White Textured (WHT)		5 Conductor Dimming Leads (DL)
		Smooth White Gloss (SWT)		Marine Grade Finish (MGF)
		Silver Metallic (SVR)		Black Hardware (BH)Ⓢ
		Black Textured (BLK)		Black Optic Frame (BOF)Ⓢ
		Smooth Black Gloss (SBK)		Buy American Act (BAA)Ⓢ
		Graphite Textured (GPH)		Trade Agreement Act (TAA)Ⓢ
		Grey Textured (GRY)		Build America Buy American (BABA)Ⓢ
		Green Textured (GRN)		Diffused Polycarbonate Visual Comfort Lens (DPCL)
		Hunter Green Textured (HGN)		Clear Tempered Glass Lens (CTG)
		Custom (CS)		

Notes:

- Ⓢ Static Colors Only. Consult Factory
- Ⓢ Consult Factory for Lead Time. Consult Factory for 90 CRI Requests
- Ⓢ House Side Shield for T2, T3, T4 only
- Ⓢ 64L Config. Only
- Ⓢ Consult Factory for lead times
- Ⓢ Wall Mount Bracket WM-SFA Required
- Ⓢ Please contact Factory for Custom Control Integration requests (nLight, NX, WaveLinx, Crestron, DMX/RDM, Synapse, Casambi, Dali II, Avi-On, or other control systems)
- Ⓢ Turtle Safe
- Ⓢ Consult factory for all BAA/TAA/BABA requests
- Ⓢ Not Available With Lens Options
- Ⓢ Consult Factory for Lead Time



701 Kingshill Place, Carson, CA 90746
Call Us Today (310) 341-2037

nslighting.com

PRODUCT SPECIFICATIONS

ELECTRICAL

- 120-277 Volts (UNV) or 347-480 Volts (HV)
- 0-10V dimming driver
- Driver power factor at maximum load is $\geq .95$, THD maximum load is 15%
- LED Drivers Ambient Temp. Min is -40°C and Ambient Temp. Max ranges from 50°C to 55°C and, in some cases, even higher. Consult the factory for revalidation by providing the fixture catalog string before quoting and specifying it.
- All drivers, controls, and sensors housed in enclosed IP66 compartment
- CRI 70, 80 or 90
- Color temperatures: 2700K, 3000K, 3500K, 4000K, 5000K
- Surge Protection: 20KVA supplied as standard.

CONSTRUCTION

- Die Cast Aluminum
- Internal cooling fins
- Corrosion resistant external hardware
- One-piece silicone gasket ensures IP66 seal for electronics compartment

OPTICS

Silicone optics high thermal stability and light output provide higher powered LEDs with minimized lumen depreciation. UV stability with scratch resistance increases exterior application durability. Silicone optics do not yellow, crack or brittle over time

CONTROL OPTIONS

- Controls Agnostic: Please contact factory for your preferred controls option. (nLight, NX, WaveLinx, Crestron, DMX/RDM, Synapse, Casambi, DALI II, Avi-On, or other control systems)

OPTIONS

- TAMPER PROOF HARDWARE - Provided to protect the optical assembly and the driver compartment for vandal resistance.
- 5 CONDUCTOR DIMMING LEADS—Standard Dimming Leads exiting the fixture for external dimming control.
- MARINE GRADE FINISH (MGF) - A multi-step process creating protective finishing coat against harsh environments.
 - Chemically washed in a 5 stage cleaning system.
 - Pre-baked
 - Powder coated 3-5 mils of Zinc Rich Super Durable Polyester Primer.
 - Oven Baked.
 - Finished Powder Coating of Super Durable Polyester Powder Coat 3-5 mil thickness.
- BLACK HARDWARE (BH) - Optional black, zinc coated steel hardware.
- BLACK OPTIC FRAME (BOF) - Optional black optic frame. Standard is white.

FINISH

- 3-5 mils electrostatic powder coat.
- NLS Lighting standard high-quality finishes prevent corrosion, and protects against extreme environmental conditions.

WARRANTY

Five-year limited warranty for drivers and LEDs. Consult Factory for 7 or 10 year warranty

LISTINGS

- Certified to UL 1598
- UL 8750
- CSA C22.2 No. 250.0
- IP66 Rated Fixture
- IP67 Rated Optics
- IK10 Rated

BUY AMERICAN OPTION

While all of the NLS Lighting products listed in this document qualify for the Buy America(n) Act of 1933, we reserve the right to change our listings without notice.

The information provided above is for general informational purposes only. We encourage you to consult legal professionals for advice particular to your projects concerning BAA, TAA, BABA or Buy America.

Additional NLS Products that meet BAA, TAA standards can be found at the following link:

<https://nlsighting.com/buy-american/>



The information and specifications on this document are subject to change without any notification. All values are design, nominal, typical or prorated values when measured under internal and external laboratory conditions.



701 Kingshill Place, Carson, CA 90746
Call Us Today (310) 341-2037

nlsighting.com

PRODUCT SPECIFICATIONS

LUMEN CHART									
Part Number	15°	LM/W	30°	LM/W	55°	LM/W	85°	LM/W	WATTS
ORX-F3-144L-700-27K7	29287	94	29644	96	30859	100	31956	103	310
ORX-F3-144L-700-27K8	27422	88	27757	90	28894	93	29922	97	310
ORX-F3-144L-700-30K8	29401	95	29759	96	30979	100	32081	103	310
ORX-F3-144L-700-30K7	31665	102	32051	103	33364	108	34551	111	310
ORX-F3-144L-700-35K8	29401	95	29759	96	30979	100	32081	103	310
ORX-F3-144L-700-40K8	31665	102	32051	103	33364	108	34551	111	310
ORX-F3-144L-700-40K7	34214	110	34631	112	36050	116	37332	120	310
ORX-F3-144L-700-50K8	31665	102	32051	103	33364	108	34551	111	310
ORX-F3-144L-700-50K7	34214	110	34631	112	36050	116	37332	120	310
ORX-F3-144L-800-27K7	33471	94	33879	95	35267	99	36522	103	355
ORX-F3-144L-800-27K8	31340	88	31722	89	33022	93	34196	96	355
ORX-F3-144L-800-30K8	33601	95	34011	96	35404	100	36664	103	355
ORX-F3-144L-800-30K7	36189	102	36630	103	38131	107	39487	111	355
ORX-F3-144L-800-35K8	33601	95	34011	96	35404	100	36664	103	355
ORX-F3-144L-800-40K8	36189	102	36630	103	38131	107	39487	111	355
ORX-F3-144L-800-40K7	39102	110	39578	111	41200	116	42666	120	355
ORX-F3-144L-800-50K8	36189	102	36630	103	38131	107	39487	111	355
ORX-F3-144L-800-50K7	39102	110	39578	111	41200	116	42666	120	355
ORX-F3-144L-900-27K7	37655	94	38114	95	39675	99	41087	103	400
ORX-F3-144L-900-27K8	35257	88	35687	89	37149	93	38471	96	400
ORX-F3-144L-900-30K8	37801	95	38262	96	39830	100	41247	103	400
ORX-F3-144L-900-30K7	40712	102	41209	103	42897	107	44423	111	400
ORX-F3-144L-900-35K8	37801	95	38262	96	39830	100	41247	103	400
ORX-F3-144L-900-40K8	40712	102	41209	103	42897	107	44423	111	400
ORX-F3-144L-900-40K7	43989	110	44526	111	46350	116	47999	120	400
ORX-F3-144L-900-50K8	40712	102	41209	103	42897	107	44423	111	400
ORX-F3-144L-900-50K7	43989	110	44526	111	46350	116	47999	120	400
ORX-F3-144L-1A-27K7	41838	94	42349	95	44084	99	45652	103	445
ORX-F3-144L-1A-27K8	39175	88	39652	89	41277	93	42745	96	445
ORX-F3-144L-1A-30K8	42001	94	42513	96	44255	99	45830	103	445
ORX-F3-144L-1A-30K7	45236	102	45787	103	47663	107	49359	111	445
ORX-F3-144L-1A-35K8	42001	94	42513	96	44255	99	45830	103	445
ORX-F3-144L-1A-40K8	45236	102	45787	103	47663	107	49359	111	445
ORX-F3-144L-1A-40K7	48877	110	49473	111	51500	116	53332	120	445
ORX-F3-144L-1A-50K8	45236	102	45787	103	47663	107	49359	111	445
ORX-F3-144L-1A-50K7	48877	110	49473	111	51500	116	53332	120	445



701 Kingshill Place, Carson, CA 90746
Call Us Today (310) 341-2037

nlsighting.com

PRODUCT SPECIFICATIONS

MODEL	WIDTH	HEIGHT	WEIGHT
ORX-F3	25"	3.2"	32LBS

EPA	ORX-F3
	.26ft²

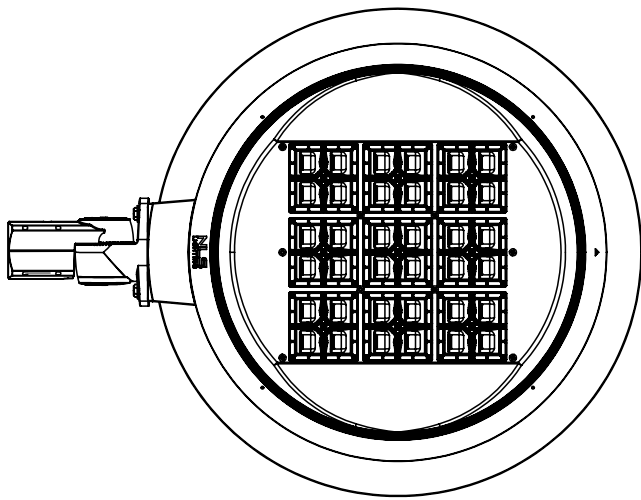
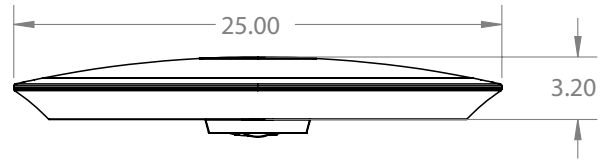
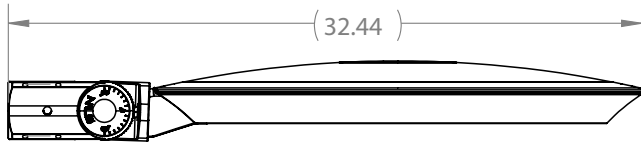

PRODUCT SPECIFICATIONS

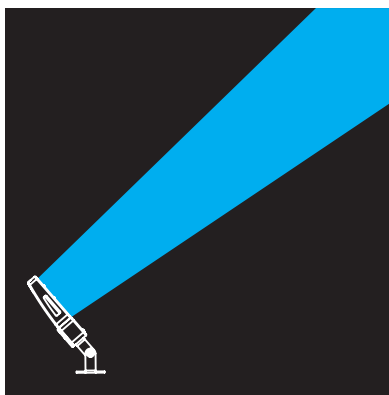
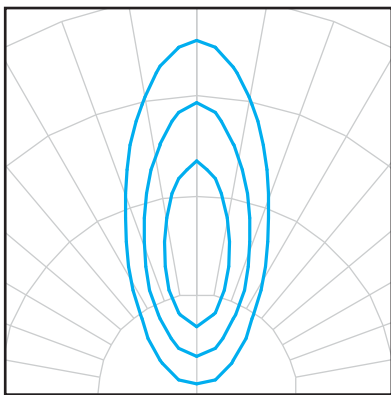

15° Very Narrow Beam Optic

The 15° Optic is used for very specific spot lighting. Spot Lighting a statue, a monument, or a piece of art. The NV Floods can be used indoors and outdoors. Pair the 15° Optic with the following Glare Control Options for more dramatic effect. Snoot Short (SNS), Snoot Long (SNL), or Egg Crate Louvers (ECL). These Glare Control Options help reduce glare and focus the viewing angles.

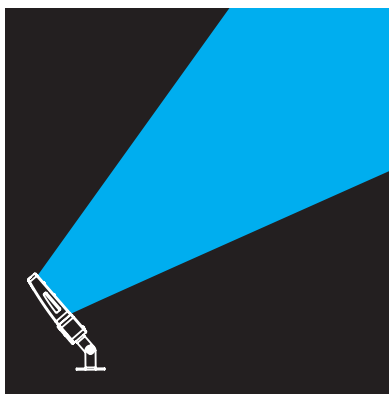
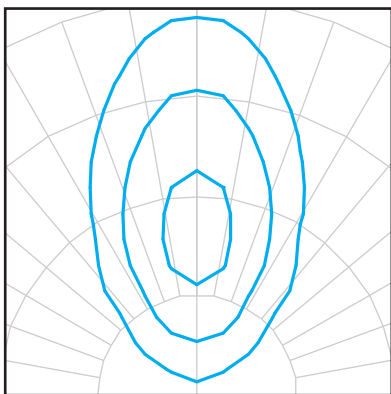

30° Narrow Beam Optic

The 30° Optic is used for larger objects and for spot and accent lighting. The 30° is perfect for Flag Lighting, Facade Lighting and great for showcasing Car Dealerships, display pads. Pair the 30° Optic with the following Glare Control Options for more dramatic effect. Snoot Short (SNS), Snoot Long (SNL), or Egg Crate Louvers (ECL). These Glare Control Options help reduce glare and focus the viewing angle.

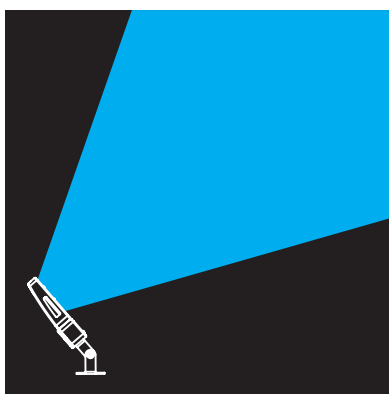
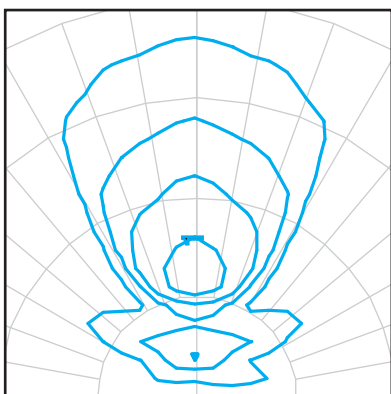

55° Medium Beam Optic

The 55° Optic is used for larger objects, flood lighting. The 55° is perfect for Facade Lighting, Landscape and general flood lighting. Pair the 55° Optic with the following Glare Control Options for more dramatic effect. Snoot Short (SNS), Angled Visor (AGV), These Glare Control Options help reduce glare and focus the beam angles.

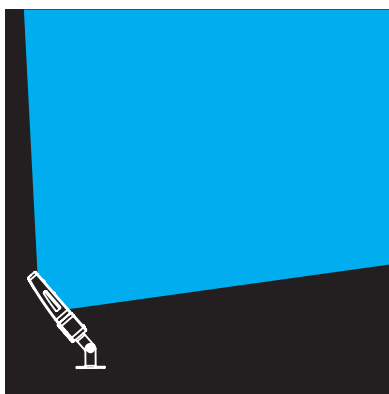
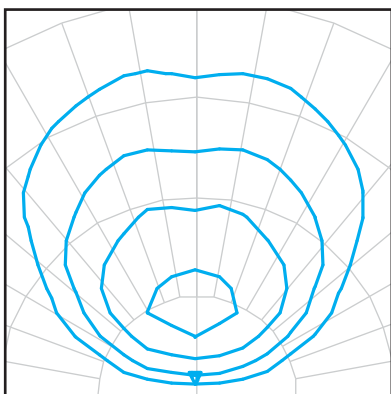

85° Wide Flood Optic

The 85° Optic is used for large area and accent lighting. The 85° is perfect for Security Lighting, general flood lighting and area lighting. Pair the 85° Optic with the following Glare Control Options for more dramatic effect. Snoot Small (SNS), Angled Visor (AGV), These Glare Control Options help reduce glare and shield unnecessary light.

PRODUCT SPECIFICATIONS

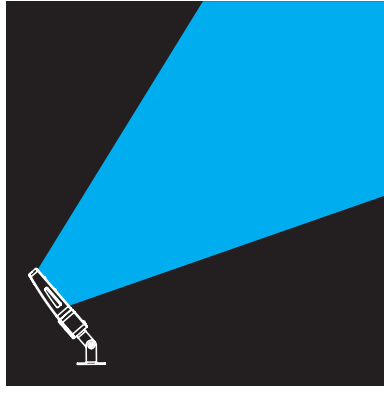
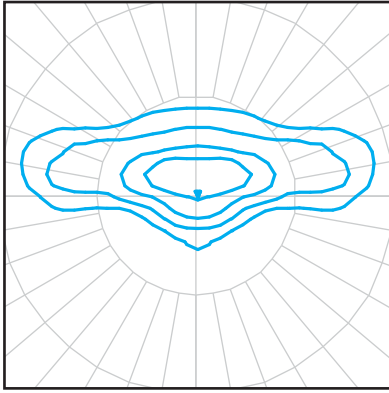

NEMA 7X5 T2 Flood Optic

The Type II (T2) distribution is used for narrow pathways and trails, narrow entrances of shopping centers, parking lots and office complex's.

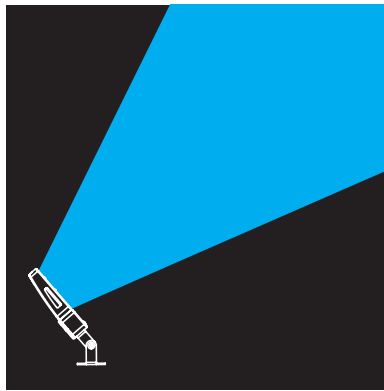
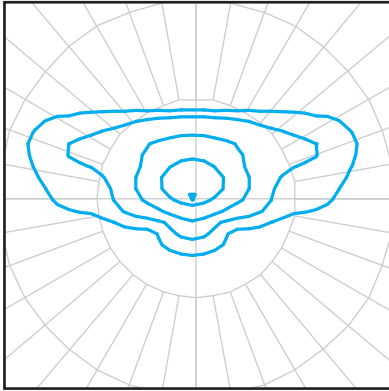

NEMA 7X6 T3 Flood Optic

The Type III (T3) distribution is meant for roadway lighting, general parking areas and other areas where a larger area of lighting is required. Type III lighting needs to be placed to the side of the area, allowing the light to project outward and fill the area. This produces a filling light flow.

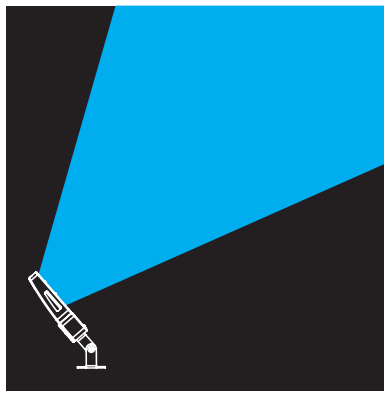
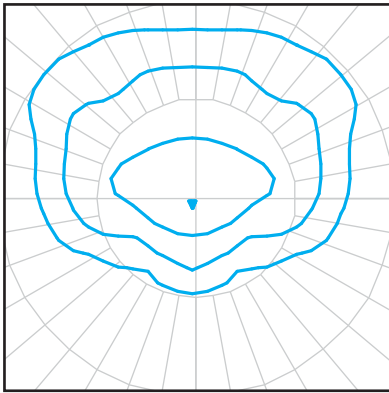

NEMA 6X6 Forward Throw T4 Flood Optic

The Type IV (T4) distribution produces a semicircular light meant for mounting on the sides of buildings and walls. It is best for illuminating the perimeter of parking areas and businesses. The intensity of the Type IV lighting has the same intensity at angles from 90° to 270°.

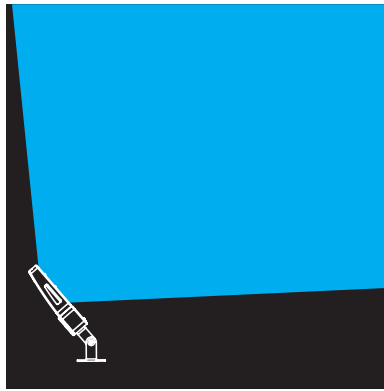
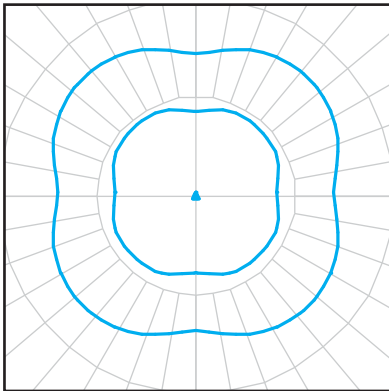

NEMA 7X7 Symmetrical T5 Flood Optic

The Type V (T5) produces a symmetrical distribution that has the same intensity at all angles. This distribution has a uniform symmetry of candlepower that is essentially the same at all lateral angles. It is meant for large, commercial parking lot lighting as well as areas where sufficient, evenly distributed light is necessary.

PRODUCT SPECIFICATIONS

Lumen Maintenance Data							
Ambient Temperature	Drive Current	L90 Hours*	L70 Hours**	30,000 Hours*	50,000 Hours*	60,000 Hours*	100,000 Hours**
25°C	Up to 700mA	58,000	173,000	95.7%	91.6%	89.6%	82.1%
	1000mA	48,000	143,000	94.3%	89.5%	87.2%	78.5%
*Reported extrapolations per IESNA TM-21				**Projected extrapolations per IESNA TM-21			
Lumen Maintenance Data (For Static Colors, Please Contact Factory)							

LED KELVIN RANGE

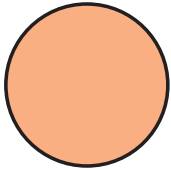

2700K 80 CRI

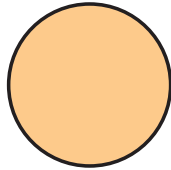

3000K 70 CRI

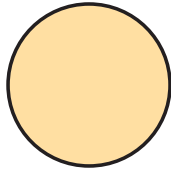

3500K 80 CRI

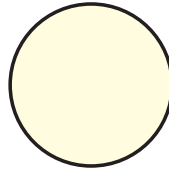

4000K 70 CRI

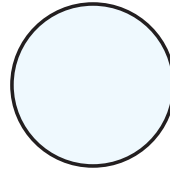

5000K 70 CRI

STATIC COLOR LED

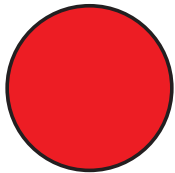

RED
624-634 nm

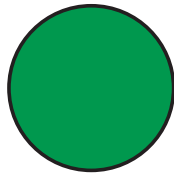

GREEN
520-540 nm

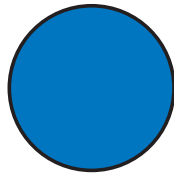

ROYAL BLUE
440-460nm

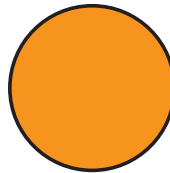

AMBER
585-600 nm

PRODUCT SPECIFICATIONS

VISOR ACCESSORY (VR)

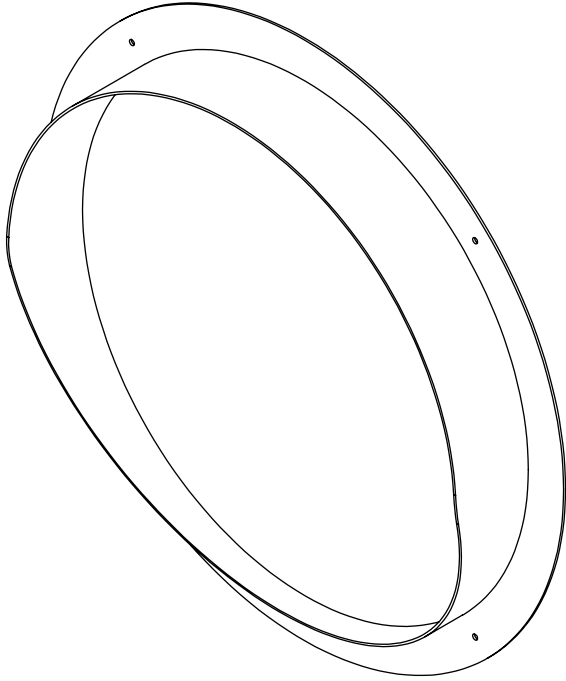

VISOR ACCESSORY (VR)

Visor Accessory cut off precision spot lighting. Laser cut precision formed aluminum construction. Powder Coated flat black as standard.

HOUSE SIDE SHIELD (HSS)

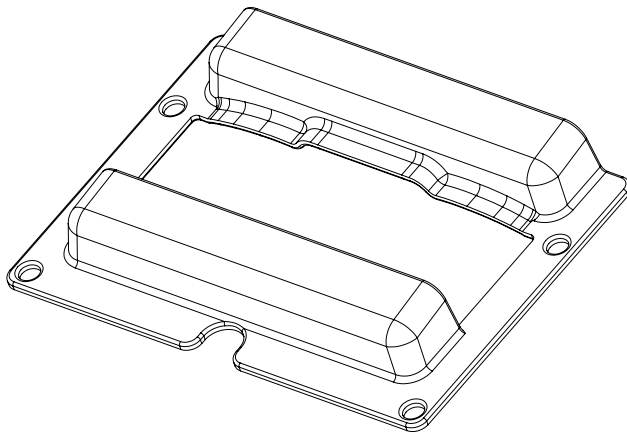

House Side Shield (HSS)

House Side Shield (**HSS**) is designed for stringent property line cutoff. Injection Molded Glass Filled Nylon, standard finish is black.

MARINE GRADE FINISH



Marine Grade Finish (MGF)

The **(MGF)** is a multi step process. Chemically washed in a 5 stage cleaning system. Pre-baked. Powder coated 3-5 mil of Zinc Rich Super Durable Polyester Primer. Oven Baked. Finished Powder Coating of Super Durable Polyester Powder Coat 3-5 mil thickness.

5 CONDUCTOR DIMMING LEADS

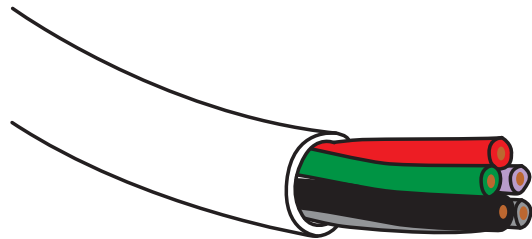

5 Conductor Dimming Leads (DL)

Standard Dimming Leads exiting the fixture for external dimming control.

PRODUCT SPECIFICATIONS

TAMPER PROOF HARDWARE

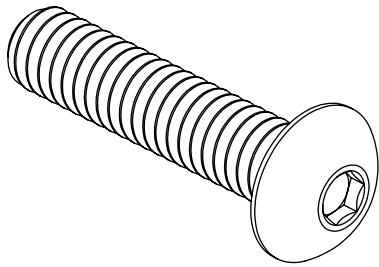

Tamper Proof Hardware (TPH)

316 Stainless Steel Button Head Hex Drive Screws. Provided to protect the optical assembly and the driver compartment for vandal resistance.

BLACK HARDWARE

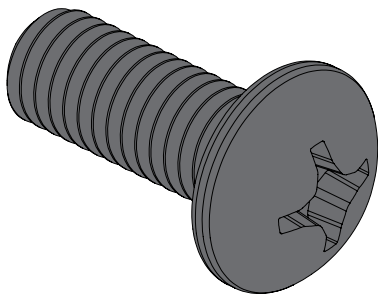

Black Hardware (BH)

Black painted hardware.

BLACK OPTIC FRAME

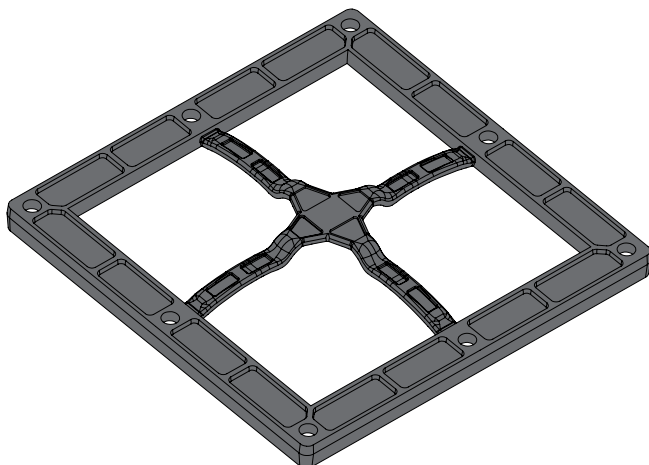

Black Optic Frame (BOF)

Optional Black Optic Frame.

PRODUCT SPECIFICATIONS

KNUCKLE MOUNT 2 3/8" (KM)

(KM) Knuckle Mount fits over a 2-3/8" Tenon. Max tilt 180°.

