



LED WATTAGE CHART

Drive Current	16L
425 milliamps	22W (2016-2539 Lumens)
530 milliamps	28W (2465-3104 Lumens)
700 milliamps	37W (3271-4120 Lumens)
1050 milliamps	55W (4283-5028 Lumens)

Form

- Elegant Die-Cast Aluminum Housing
- Corrosion Resistant Stainless Steel External Hardware
- Sleek, Low Profile Housing
- Spec Grade Performance
- Engineered For Optimum Thermal Management
- 9 Architectural Finishes Standard, RAL Colors Available

Function

- Micro Optics IES Distributions T2, T3, T4, T5 15°, 30°, 55° 85°
- 0-10V Dimming Drivers THD @ Max Load < 15% Power factor @ Max Load < 0.95
- 2700K, 3000K, 3500K, 4000K, or 5000K
- 4 Static LED Color Options
- 16L LED Configuration
- CRI 70, 80, or 90
- 5 Mils Powder Coat

Reliability

- 5 Year Standard Warranty
- Silicone Micro Optics
- IP67 Optics
- IP66 Fixture
- IK10 Rated Optics



Project Name:

Type:

ORGANIX - F1 - ORDERING GUIDE

Cat#	Optics	No. of LEDs	Watts	Kelvin Temp		Volts
Organix - Flood (ORX-F1)	15° Very Narrow (15) ①	16 (16L)	22W (22W) ①	2700K, 70 CRI (27K7)	Red 624-634nm (RED) ①	120-277 (UNV)
	30° Narrow Beam (30) ①		28W (28W) ①	2700K, 80 CRI (27K8) ②	Amber 585-600nm (AMBER) ③ ④ ⑤ ⑥	
	55° Medium Beam (55)		37W (37W)	3000K, 70 CRI (30K7)	Green 520-540nm (GREEN) ①	
	85° Wide Beam (85)		55W (55W)	3000K, 80 CRI (30K8) ②	Royal Blue 440-460nm (BLUE) ①	
	IES T2 / NEMA 7Hx5V (T2)			3500K, 80 CRI (35K8)		
	IES T3 / NEMA 7Hx6V (T3)			4000K, 70 CRI (40K7)		
	Forward Throw (T4)			4000K, 80 CRI (40K8) ②		
	Symmetrical (T5)			5000K, 70 CRI (50K7)		
				5000K, 80 CRI (50K8) ②		

Mounting	Mounting Accessories	Color	Control Options	Options
Knuckle Mount (KM)	Stanchion Caps Stanchion Cap for Knuckle Mount (KMS2) 2 3/8" ID Stanchion Cap Stanchion Cap for Knuckle Mount (KMS3) ① With 3" ID Stanchion Cap Stanchion Cap for Knuckle Mount (KMS4) With 4" ID Stanchion Cap	Stanchion Post 12" Length (STP12) 24" Length (STP24) 36" Length (STP36) Custom Length (STPX) Universal Magic Mount (UMM) UMM Must be ordered with KM 4" Round J-Box Mount for Knuckle (JBRK) No Mounting Accessories (NA)	Bronze Textured (BRZ) White Textured (WHT) Smooth White Gloss (SWT) Silver Metallic (SVR) Black Textured (BLK) Smooth Black Gloss (SBK) Graphite Textured (GPH) Grey Textured (GRY) Green Textured (GRN) Hunter Green Textured (HGN) Custom (CS)	Custom Controls Integration (CCI) ② 5 Conductor Dimming Leads (DL) Marine Grade Finish (MGF) Black Hardware (BH) Black Optic Frame (BOF) Tamper Proof Hardware (TPH) Buy American Act (BAA) ③ Trade Agreement Act (TAA) ③ Build America Buy American (BABA) ③ Visor Accessory (VR) Clear Tempered Glass Lens (CTG)

Notes:

- ① Static Colors Consult Factory
- ② Consult Factory for Lead Time. Consult Factory for 90 CRI Requests.
- ③ Universal Voltage 120-277
- ④ STP Must be ordered with KMS3
- ⑤ Please Contact Factory for Custom Control Integration requests (nLight, NX, WaveLinx, Crestron, DMX/RDM, Synapse, Casambi, Dali II, Avi-On, or other control systems)
- ⑥ Turtle Safe
- ⑦ Consult Factory for all BAA/TAA/BABA requests
- ⑧ Not Available with Lens Option
- ⑨ Not Available above 37W
- ⑩ Consult Factory for Lead Time



701 Kingshill Place, Carson, CA 90746
Call Us Today (310) 341-2037

nslighting.com

PRODUCT SPECIFICATIONS

ELECTRICAL

- 120-277 Volts (UNV)
- 0-10V dimming driver
- Driver power factor at maximum load is $\geq .95$, THD maximum load is 15%
- LED Drivers Ambient Temp. Min is -40°C and Ambient Temp. Max ranges from 50°C to 55°C and, in some cases, even higher. Consult the factory for revalidation by providing the fixture catalog string before quoting and specifying it.
- All drivers, controls, and sensors housed in enclosed IP66 compartment
- CRI 70, 80 or 90
- Color temperatures: 2700K, 3000K, 3500K, 4000K, 5000K
- Surge Protection: 20KVA supplied as standard.

CONSTRUCTION

- Die Cast Aluminum
- Internal cooling fins
- Corrosion resistant external hardware
- One-piece silicone gasket ensures IP66 seal for electronics compartment

OPTICS

Silicone optics high thermal stability and light output provide higher powered LEDs with minimized lumen depreciation. UV stability with scratch resistance increases exterior application durability. Silicone optics do not yellow, crack or brittle over time

CONTROL OPTIONS

- Controls Agnostic: Please contact factory for your preferred controls option. (nLight, NX, WaveLinx, Crestron, DMX/RDM, Synapse, Casambi, DALI II, Avi-On, or other control systems)

OPTIONS

- TAMPER PROOF HARDWARE - Provided to protect the optical assembly and the driver compartment for vandal resistance.
- 5 CONDUCTOR DIMMING LEADS—Standard Dimming Leads exiting the fixture for external dimming control.
- MARINE GRADE FINISH (MGF) - A multi-step process creating protective finishing coat against harsh environments.
 - Chemically washed in a 5 stage cleaning system.
 - Pre-baked
 - Powder coated 3-5 mils of Zinc Rich Super Durable Polyester Primer.
 - Oven Baked.
 - Finished Powder Coating of Super Durable Polyester Powder Coat 3-5 mil thickness.
- BLACK HARDWARE (BH) - Optional black, zinc coated steel hardware.
- BLACK OPTIC FRAME (BOF) - Optional black optic frame. Standard is white.

FINISH

- 3-5 mils electrostatic powder coat.
- NLS Lighting standard high-quality finishes prevent corrosion, and protects against extreme environmental conditions.

WARRANTY

Five-year limited warranty for drivers and LEDs. Consult Factory for 7 or 10 year warranty

LISTINGS

- Certified to UL 1598
- UL 8750
- CSA C22.2 No. 250.0
- IP66 Rated Fixture
- IP67 Rated Optics
- IK10 Rated



The information and specifications on this document are subject to change without any notification. All values are design, nominal, typical or prorated values when measured under internal and external laboratory conditions.



701 Kingshill Place, Carson, CA 90746
Call Us Today (310) 341-2037

nlsighting.com

PRODUCT SPECIFICATIONS

LUMEN CHART									
Part Number	15°	LM/W	30°	LM/W	55°	LM/W	85°	LM/W	WATTS
ORX-F1-16L-450-27K7	2174	109	2016	101	2099	105	2174	109	22
ORX-F1-16L-450-27K8	2035	102	1888	94	1965	98	2035	102	22
ORX-F1-16L-450-30K8	2182	109	2024	101	2107	105	2182	109	22
ORX-F1-16L-450-30K7	2350	118	2180	109	2270	113	2350	118	22
ORX-F1-16L-450-35K8	2182	109	2024	101	2107	105	2182	109	22
ORX-F1-16L-450-40K8	2350	118	2180	109	2270	113	2350	118	22
ORX-F1-16L-450-40K7	2539	127	2356	118	2452	123	2539	127	22
ORX-F1-16L-450-50K8	2350	118	2180	109	2270	113	2350	118	22
ORX-F1-16L-450-50K7	2539	127	2356	118	2452	123	2539	127	22
ORX-F1-16L-550-27K7	2657	106	2465	99	2566	103	2657	106	28
ORX-F1-16L-550-27K8	2488	100	2308	92	2402	96	2488	100	28
ORX-F1-16L-550-30K8	2667	107	2474	99	2576	103	2667	107	28
ORX-F1-16L-550-30K7	2873	115	2665	107	2774	111	2873	115	28
ORX-F1-16L-550-35K8	2667	107	2474	99	2576	103	2667	107	28
ORX-F1-16L-550-40K8	2873	115	2665	107	2774	111	2873	115	28
ORX-F1-16L-550-40K7	3104	124	2879	115	2997	120	3104	124	28
ORX-F1-16L-550-50K8	2873	115	2665	107	2774	111	2873	115	28
ORX-F1-16L-550-50K7	3104	124	2879	115	2997	120	3104	124	28
ORX-F1-16L-730-27K7	3526	101	3271	93	3405	97	3526	101	37
ORX-F1-16L-730-27K8	3302	94	3063	88	3188	91	3302	94	37
ORX-F1-16L-730-30K8	3540	101	3284	94	3419	98	3540	101	37
ORX-F1-16L-730-30K7	3813	109	3537	101	3682	105	3813	109	37
ORX-F1-16L-730-35K8	3540	101	3284	94	3419	98	3540	101	37
ORX-F1-16L-730-40K8	3813	109	3537	101	3682	105	3813	109	37
ORX-F1-16L-730-40K7	4120	118	3821	109	3978	114	4120	118	37
ORX-F1-16L-730-50K8	3813	109	3537	101	3682	105	3813	109	37
ORX-F1-16L-730-50K7	4120	118	3821	109	3978	114	4120	118	37
ORX-F1-16L-950-27K7	4589	102	4257	95	4431	98	4589	102	55
ORX-F1-16L-950-27K8	4297	95	3986	89	4149	92	4297	95	55
ORX-F1-16L-950-30K8	4607	102	4273	95	4449	99	4607	102	55
ORX-F1-16L-950-30K7	4962	110	4603	102	4791	106	4962	110	55
ORX-F1-16L-950-35K8	4607	102	4273	95	4449	99	4607	102	55
ORX-F1-16L-950-40K8	4962	110	4603	102	4791	106	4962	110	55
ORX-F1-16L-950-40K7	5361	119	4973	111	5177	115	5361	119	55
ORX-F1-16L-950-50K8	4962	110	4603	102	4791	106	4962	110	55
ORX-F1-16L-950-50K7	5361	119	4973	111	5177	115	5361	119	55

Lumen Maintenance Data							
Ambient Temperature	Drive Current	L90 Hours*	L70 Hours**	30,000 Hours*	50,000 Hours*	60,000 Hours*	100,000 Hours**
25°C	Up to 700mA	58,000	173,000	95.7%	91.6%	89.6%	82.1%
	1050mA	48,000	143,000	94.3%	89.5%	87.2%	78.5%
*Reported extrapolations per IESNA TM-21				**Projected extrapolations per IESNA TM-21			

LED KELVIN RANGE

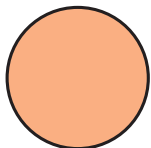

2700K 80 CRI

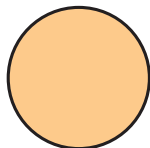

3000K 70 CRI

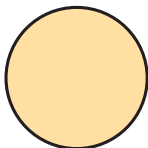

3500K 80 CRI

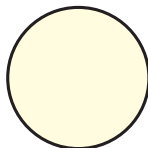

4000K 70 CRI

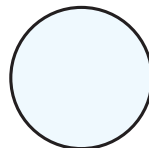

5000K 70 CRI

STATIC COLOR LED

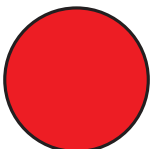

RED
624-634 nm

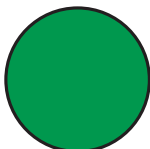

GREEN
520-540 nm

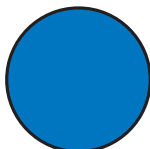

ROYAL BLUE
440-460nm

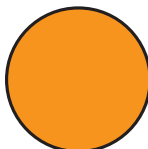

AMBER
585-600 nm

Color	Dominant or Peak Wavelength Range (nm)	
	Minimum	Maximum
Amber	585	600

PRODUCT SPECIFICATIONS

MODEL	WIDTH	HEIGHT	WEIGHT
ORX-F1	9.20"	2"	4 LBS

EPA	ORX-F1
	.05ft²

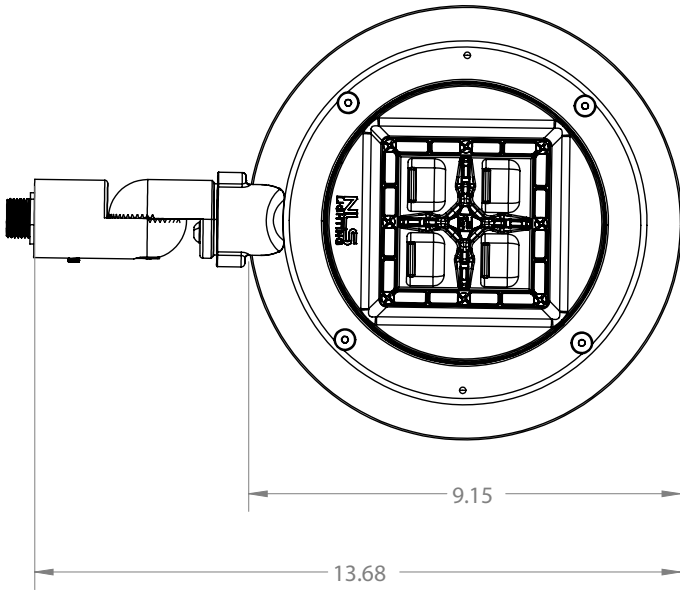
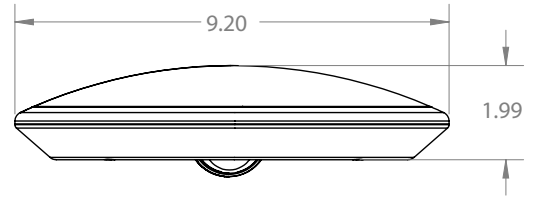
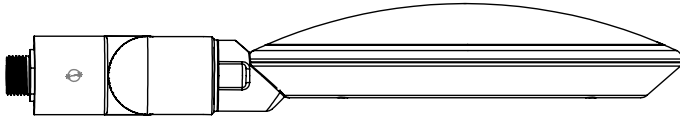

PRODUCT SPECIFICATIONS

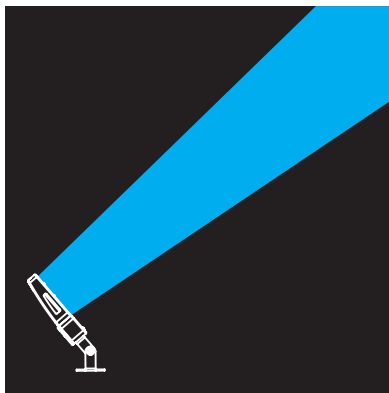
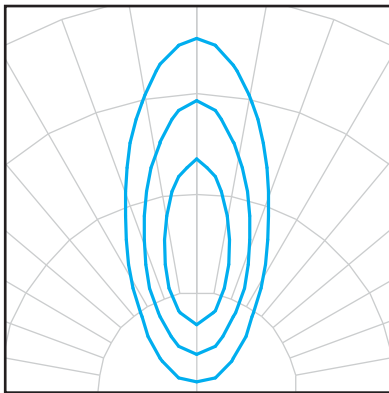

15° Very Narrow Beam Optic

The 15° Optic is used for very specific spot lighting. Spot Lighting a statue, a monument, or a piece of art. The NV Floods can be used indoors and outdoors. Pair the 15° Optic with the following Glare Control Options for more dramatic effect. Snoot Short (SNS), Snoot Long (SNL), or Egg Crate Louvers (ECL). These Glare Control Options help reduce glare and focus the viewing angles.

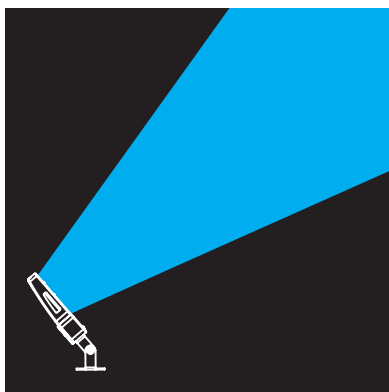
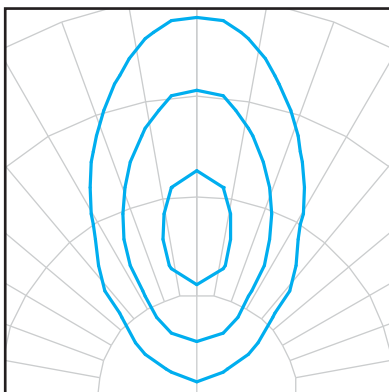

30° Narrow Beam Optic

The 30° Optic is used for larger objects and for spot and accent lighting. The 30° is perfect for Flag Lighting, Facade Lighting and great for showcasing Car Dealerships, display pads. Pair the 30° Optic with the following Glare Control Options for more dramatic effect. Snoot Short (SNS), Snoot Long (SNL), or Egg Crate Louvers (ECL). These Glare Control Options help reduce glare and focus the viewing angle.

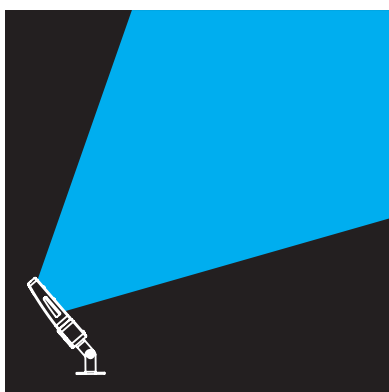
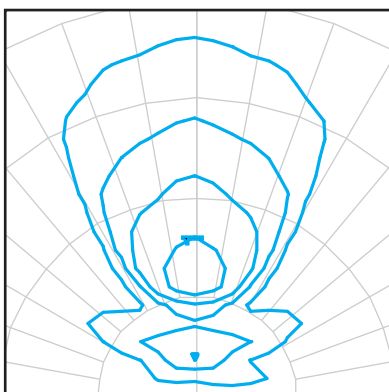

55° Medium Beam Optic

The 55° Optic is used for larger objects, flood lighting. The 55° is perfect for Facade Lighting, Landscape and general flood lighting. Pair the 55° Optic with the following Glare Control Options for more dramatic effect. Snoot Short (SNS), Angled Visor (AGV), These Glare Control Options help reduce glare and focus the beam angles.

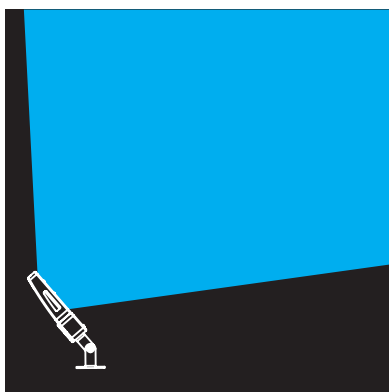
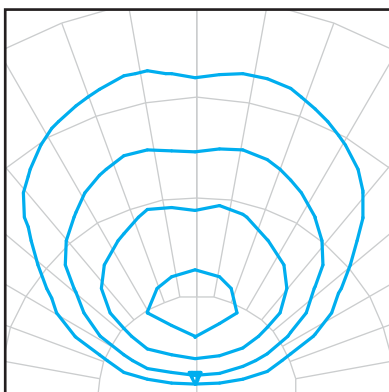

85° Wide Flood Optic

The 85° Optic is used for large area and accent lighting. The 85° is perfect for Security Lighting, general flood lighting and area lighting. Pair the 85° Optic with the following Glare Control Options for more dramatic effect. Snoot Small (SNS), Angled Visor (AGV), These Glare Control Options help reduce glare and shield unnecessary light.

PRODUCT SPECIFICATIONS

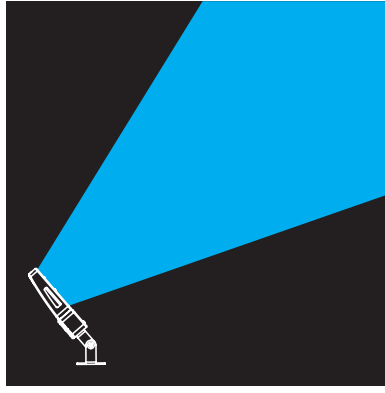
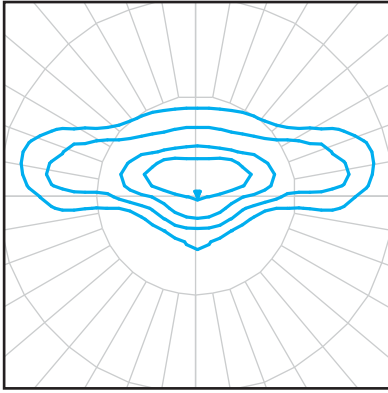

NEMA 7X5 T2 Flood Optic

The Type II (T2) distribution is used for narrow pathways and trails, narrow entrances of shopping centers, parking lots and office complex's.

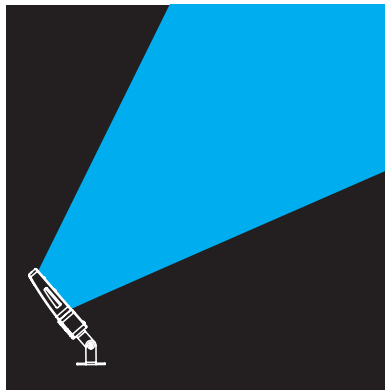
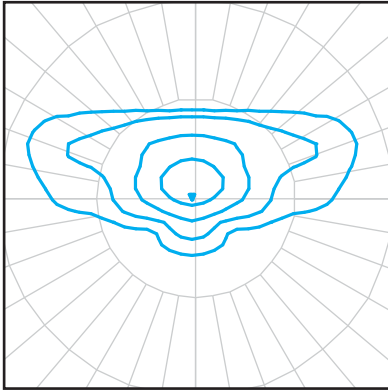

NEMA 7X6 T3 Flood Optic

The Type III (T3) distribution is meant for roadway lighting, general parking areas and other areas where a larger area of lighting is required. Type III lighting needs to be placed to the side of the area, allowing the light to project outward and fill the area. This produces a filling light flow.

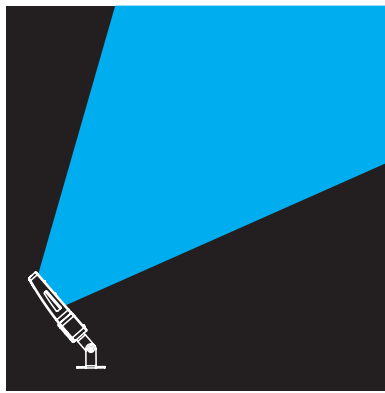
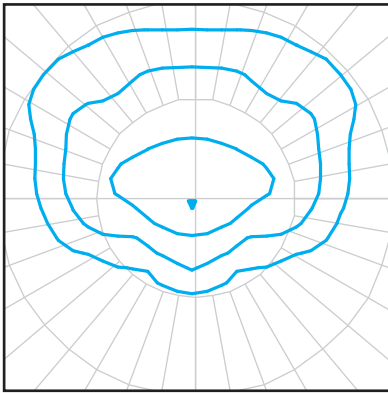

NEMA 6X6 Forward Throw T4 Flood Optic

The Type IV (T4) distribution produces a semicircular light meant for mounting on the sides of buildings and walls. It is best for illuminating the perimeter of parking areas and businesses. The intensity of the Type IV lighting has the same intensity at angles from 90° to 270°.

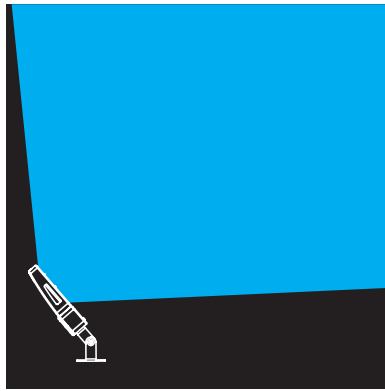
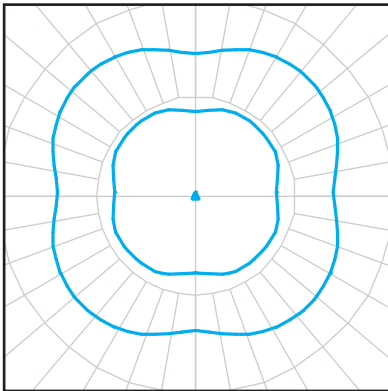

NEMA 7X7 Symmetrical T5 Flood Optic

The Type V (T5) produces a symmetrical distribution that has the same intensity at all angles. This distribution has a uniform symmetry of candlepower that is essentially the same at all lateral angles. It is meant for large, commercial parking lot lighting as well as areas where sufficient, evenly distributed light is necessary.

PRODUCT SPECIFICATIONS

HOUSE SIDE SHIELD (HSS)

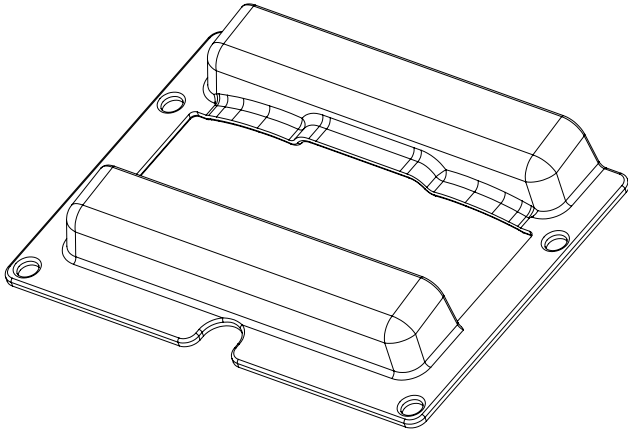

House Side Shield (HSS)

House Side Shield (**HSS**) is designed for stringent property line cutoff. Injection Molded Glass Filled Nylon, standard finish is black.

FIXTURE FEATURES & OPTIONS

MARINE GRADE FINISH



Powder Coat Finish
3-5 mil Powder Coat

Primer Layer
3-5 mil Zinc Rich
Super Durable Polyester Primer

Prepared Casting
Chemically washed in multi Step 5 stage
cleaning process

Marine Grade Finish (MGF)

The (**MGF**) is a multi step process. Chemically washed in a 5 stage cleaning system. Pre-baked. Powder coated 3-5 mils of Zinc Rich Super Durable Polyester Primer. Oven Baked. Finished Powder Coating of Super Durable Polyester Powder Coat 3-5 mil thickness.

5 CONDUCTOR DIMMING LEADS

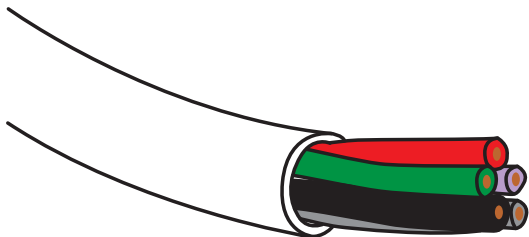

5 Conductor Dimming Leads (DL)

Standard Dimming Leads exiting the fixture for external dimming control.

PRODUCT SPECIFICATIONS

TAMPER PROOF HARDWARE

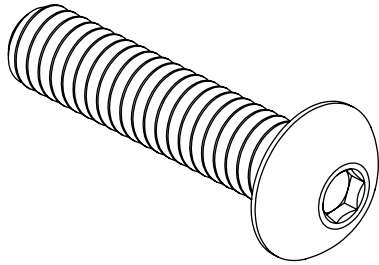

Tamper Proof Hardware (TPH)

316 Stainless Steel Button Head Hex Drive Screws. Provided to protect the optical assembly and the driver compartment for vandal resistance.

BLACK HARDWARE

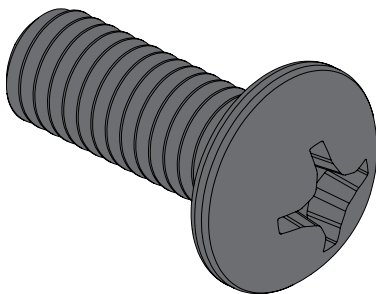

Black Hardware (BH)

Black painted hardware.

BLACK OPTIC FRAME

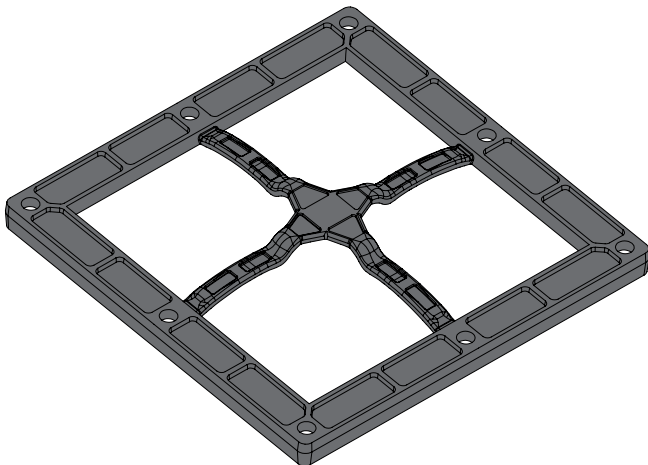

Black Optic Frame (BOF)

Optional Black Optic Frame.

PRODUCT SPECIFICATIONS

KNUCKLE MOUNT 1/2" NPT (KM)

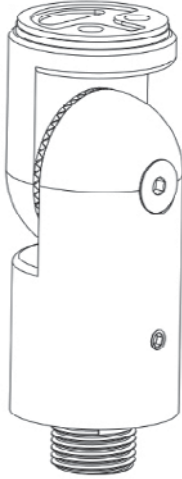

(KM) Knuckle Mount has a 1/2" NPT nipple.

STANCHION CAP FOR KNUCKLE MOUNT

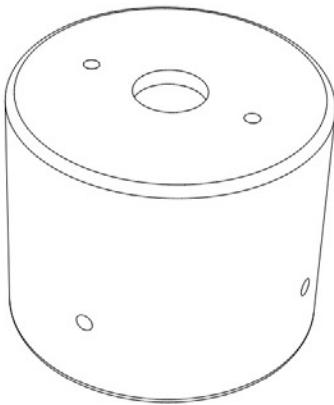

(KMS2) Stanchion Cap fits over a 2 3/8" O.D. Tenon.

(KMS3) Stanchion Cap fits over a 3" O.D. Tenon.

(KMS4) Stanchion Cap fits over a 4" O.D. Tenon.

4" ROUND JBOX KNUCKLE MOUNT (JBRK)

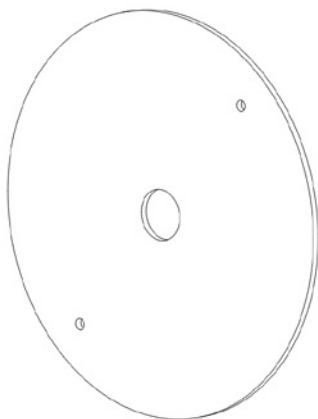

(JBRK) 4" Round J-Box cover plate mount.

VISOR ACCESSORY (VR)

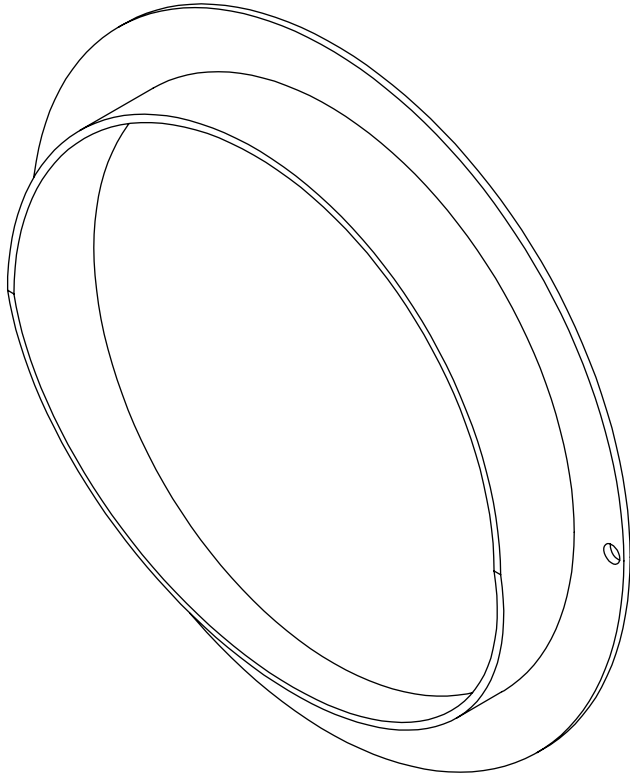

VISOR ACCESSORY (VR)

Visor Accessory cut off precision spot lighting. Laser cut precision formed aluminum construction. Powder Coated flat black as standard.



UNIVERSAL MAGIC MOUNT

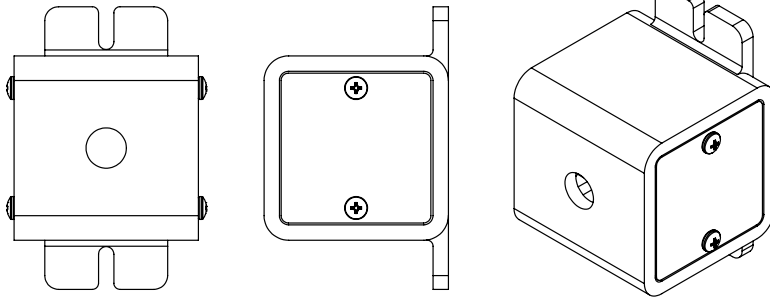

Universal Magic Mount (UMM)

The **(UMM)** allows Knuckle Mount for a single fixture and thru-conduit 1/2" or 3/4". The **(UMM)** was designed for universal mounting to walls, ceilings, trees, poles, parapets, and eaves.

