



LED WATTAGE CHART

Drive Current	16L	32L	64L	64L VCS
350 milliamps	-	34W (3158-3689 Lumens)	68W (6316-7530 Lumens)	68W (6316-7530 Lumens)
400 milliamps	18W (1579-1882 Lumens)	-	-	-
530 milliamps	26W (2391-2850 Lumens)	52W (4782-5701 Lumens)	103W (9564-11402 Lumens)	103W (9564-11402 Lumens)
700 milliamps	34W (3158-3765 Lumens)	68W (3616-7529 Lumens)	137W (12632-15059 Lumens)	137W (12632-15059 Lumens)
1000 milliamps	-	-	200W (18045-21513 Lumens)	200W (18045-21513 Lumens)
1050 milliamps	51W (4737-5647 Lumens)	102W (9474-11294 Lumens)	-	-
1050 milliamps	-	125W (10560 - 13543 Lumens)	-	-
1400 milliamps	-	140W (11827-15168 Lumens)	-	-

FORM

- Elegant Die-Cast Aluminum Housing
- Corrosion Resistant Stainless Steel External Hardware
- Sleek, Low Profile Housing
- Spec Grade Performance
- Engineered For Optimum Thermal Management
- 9 Architectural Finishes Standard, RAL Colors Available

FUNCTION

- Micro Optics IES Distributions T2, T3, T4, VCS, VCA
- 0-10V Dimming Drivers
THD @ Max Load < 15%
Power factor @ Max Load < 0.95
- Amber, 2700K, 3000K, 3500K, 4000K, or 5000K
- 16L, 32L, or 64L LED Configuration
- CRI 70, 80, or 90
- 5 Mills Powder Coat
- Up to 21,513 Lumens

RELIABILITY

- Silicone Micro Optics
- 5 Year Standard Warranty
- IP67 Optics
- IP66 Fixture

BUY AMERICAN

To ensure the latest BAA/TAA/BABA Standards are being met, please select BAA, TAA, or BABA in the options section. Please contact the factory before placing an order for any NLS products requesting BAA (Buy American Act), TAA (Trade Agreement Act), or BABA (Build America, Buy America).



Project Name:

Type:

ORGANIX - 2 WALL MOUNT - ORDERING GUIDE

Cat#	Light Dist.	No. of LEDs	Milliamps	Kelvin Temp	Volts
Organix - Wall Mount (ORX-2-W)	Type 2 (T2)	16 (16L)	350 (35)	Amber 585-600nm (AMBER) ③ ④ ⑤	120-277 (UNV)
	Type 3 (T3)	32 (32L)	400 (40) ⑥	2700K, 70 CRI (27K7)	347-480 (HV)
	Type 4 (T4)	64 (64L)	530 (53)	2700K, 80 CRI (27K8) ①	
	Visual Comfort Symmetric (VCS) ⑦		700 (7)	3000K, 70 CRI (30K7)	
	Visual Comfort Assymmetric (VCA) ⑦		1000 (1A)	3000K, 80 CRI (30K8) ①	
			1050 (1)	3500K, 80 CRI (35K8)	
			1250 (1) ⑧	4000K, 70 CRI (40K7)	
			1400 (1)	4000K, 80 CRI (40K8) ①	
				5000K, 70 CRI (50K7)	
				5000K, 80 CRI (50K8) ①	

Mounting	Color	Control Options	Options	Lens Options
Wall Mount (WM)	Bronze Textured (BRZ)	FSP-211 with Motion Sensor (FSP-8) ⑨ ⑩	Tamper Proof Hardware (TPH)	Diffused Polycarbonate Visual Comfort Lens (DPCL)
	White Textured (WHT)	8' Heights and Below (FSP-20) ⑨ ⑩	Marine Grade Finish (MGF)	Clear Tempered Glass Lens (CTG)
	Smooth White Gloss (SWT)	*9'-20" Heights (FSP-40) ⑨ ⑩	House Side Shield (HSS)	
	Silver Metallic (SVR)	*21'-40" Heights (FSP-40) ⑨ ⑩	Black Hardware (BH)	
	Black Textured (BLK)	Custom Controls Integration (CCI) ⑥	Black Optic Frame (BOF)	
	Smooth Black Gloss (SBK)	FSP Remote (FSIR) ⑧	Buy American Act (BAA) ⑪	
	Graphite Textured (GPH)		Trade Agreement Act (TAA) ⑫	
	Grey Textured (GRY)		Build America Buy American (BABA) ⑬	
	Green Textured (GRN)			
	Hunter Green Textured (HGN)			
	Custom (CS)			

Notes:

- ① Consult Factory for Lead Time. Consult Factory For 90 CRI Requests
- ② Universal Voltage 120-277
- ③ 3000k or warmer must be selected to meet International Dark-Sky Association certification.
- ④ Please contact Factory for Custom Control Integration requests (nLight, NX, WaveLinX, Crestron, DMX/RDM, Synapse, Casambi, Dali II, Avi-On, or other control systems)
- ⑤ Turtle Safe
- ⑥ Consult factory for all BAA/TAA/BABA requests
- ⑦ 64L Only with Backlit Diffused Lens
- ⑧ Not Available in 64L
- ⑨ 16L Only
- ⑩ Not Available With Lens Options (VCA, VCS, DPCL, CTG)
- ⑪ Projects with sensors require Qty. 1 FSIR per project
- ⑫ Not Available above 1000mA
- ⑬ Consult Factory for Lead Time



701 Kingshill Place, Carson, CA 90746
Call Us Today (310) 341-2037

nslighting.com

PRODUCT SPECIFICATIONS

ELECTRICAL

- 120-277 Volts (UNV) or 347-480 Volts (HV)
- 0-10V dimming driver
- Driver power factor at maximum load is $\geq .95$, THD maximum load is 15%
- LED Drivers Ambient Temp. Min is -40°C and Ambient Temp. Max ranges from 50°C to 55°C and, in some cases, even higher. Consult the factory for revalidation by providing the fixture catalog string before quoting and specifying it.
- All drivers, controls, and sensors housed in enclosed IP65 compartment
- CRI 70, 80 or 90
- Color temperatures: Amber, 2700K, 3000K, 3500K, 4000K, 5000K
- Surge Protection: 20KVA supplied as standard.

CONSTRUCTION

- Die Cast Aluminum
- Internal cooling fins
- Corrosion resistant external hardware
- One-piece silicone gasket ensures IP66 seal for electronics compartment

OPTICS

Silicone optics high thermal stability and light output provide higher powered LEDs with minimized lumen depreciation. UV stability with scratch resistance increases exterior application durability. Silicone optics do not yellow, crack or brittle over time

CONTROL OPTIONS

CONTROL OPTIONS & FEATURES

- FSP-221 (FSP-X) - Passive infrared (PIR) sensor providing multi-level control based on motion/daylight contribution.
- All control parameters adjustable via wireless configuration remote storing and transmitting sensor profiles.
- * Party Setting Available (10% output) Consult Factory
- * Can maintain constant foot candles over time. Consult Factory
- FSP-20 mounting heights 9-20 feet
- FSP-40 mounting heights 21-40 feet.
- Includes 5 dimming event cycles, 0-10V dimming with motion sensing, re-programmable in the field. Programmable remote must be purchased separately.
- FSIR-100 commissioning remote is required to change sensor settings. Please contact factory for ordering.

- Controls Agnostic: Please contact factory for your preferred controls option. (nLight, NX, WaveLinX, Crestron, DMX/RDM, Synapse, Casambi, DALI II, Avi-On, or other control systems)

OPTIONS

- BIRD SPIKES (BS) - Offer an effective and humane deterrent for larger bird species and provide a cost-effective long-term solution to nuisance bird infestations and to protect your property.

- MARINE GRADE FINISH (MGF) - A multi-step process creating a protective finishing coat against harsh environments. Chemically washed in a 5-stage cleaning system. Pre-baked, Powder coated 3-5 mils of Zinc Rich Super Durable Polyester Primer. Oven Baked. Finished Powder Coating of Super Durable Polyester Powder Coat 3-5 mil thickness.

- House Side Shield (HSS) is designed for full property line cutoff.

- Tamper Proof Hardware (TPH)

FINISH

- 3-5 mils electrostatic powder coat.
- NLS Lighting standard high-quality finishes prevent corrosion, and protects against extreme environmental conditions.

WARRANTY

Five-year limited warranty for drivers and LEDs.
Consult Factory for 7 or 10 year warranty

LISTINGS

- Certified to UL 1598
- UL 8750
- CSA C22.2 No. 250.0
- IP66 Rated Fixture
- IP67 Rated Optics
- IK10 Rated

BUY AMERICAN OPTION

While all of the NLS Lighting products listed in this document qualify for the Buy America(n) Act of 1933, we reserve the right to change our listings without notice.

The information provided above is for general informational purposes only. We encourage you to consult legal professionals for advice particular to your projects concerning BAA, TAA, BABA or Buy America.

Additional NLS Products that meet BAA, TAA standards can be found at the following link:

<https://nlsighting.com/buy-american/>



The information and specifications on this document are subject to change without any notification. All values are design, nominal, typical or prorated values when measured under internal and external laboratory conditions.



701 Kingshill Place, Carson, CA 90746
Call Us Today (310) 341-2037

nlsighting.com

PRODUCT SPECIFICATIONS

LUMEN CHART							
Part Number	T2	LM/W	T3	LM/W	T4	LM/W	WATTS
ORX-2-WM-16L-400-27K7	1611	90	1588	88	1579	88	18
ORX-2-WM-16L-400-27K8	1509	84	1487	83	1478	82	18
ORX-2-WM-16L-400-30K8	1618	90	1595	89	1585	88	18
ORX-2-WM-16L-400-30K7	1742	97	1717	95	1707	95	18
ORX-2-WM-16L-400-35K8	1618	90	1595	89	1585	88	18
ORX-2-WM-16L-400-40K8	1742	97	1717	95	1707	95	18
ORX-2-WM-16L-400-40K7	1882	105	1856	103	1845	102	18
ORX-2-WM-16L-400-50K8	1742	97	1717	95	1707	95	18
ORX-2-WM-16L-400-50K7	1882	105	1856	103	1845	102	18
ORX-2-WM-16L-530-27K7	2440	94	2405	93	2391	92	26
ORX-2-WM-16L-530-27K8	2285	88	2252	87	2239	86	26
ORX-2-WM-16L-530-30K8	2449	94	2415	93	2400	92	26
ORX-2-WM-16L-530-30K7	2638	101	2601	100	2585	99	26
ORX-2-WM-16L-530-35K8	2449	94	2415	93	2400	92	26
ORX-2-WM-16L-530-40K8	2638	101	2601	100	2585	99	26
ORX-2-WM-16L-530-40K7	2850	110	2810	108	2793	107	26
ORX-2-WM-16L-530-50K8	2638	101	2601	100	2585	99	26
ORX-2-WM-16L-530-50K7	2850	110	2810	108	2793	107	26
ORX-2-WM-16L-700-27K7	3223	95	3177	93	3158	93	34
ORX-2-WM-16L-700-27K8	3017	89	2974	87	2957	87	34
ORX-2-WM-16L-700-30K8	3235	95	3189	94	3170	93	34
ORX-2-WM-16L-700-30K7	3484	102	3435	101	3414	100	34
ORX-2-WM-16L-700-35K8	3235	95	3189	94	3170	93	34
ORX-2-WM-16L-700-40K8	3484	102	3435	101	3414	100	34
ORX-2-WM-16L-700-40K7	3765	111	3711	109	3689	109	34
ORX-2-WM-16L-700-50K8	3484	102	3435	101	3414	100	34
ORX-2-WM-16L-700-50K7	3765	111	3711	109	3689	109	34
ORX-2-WM-16L-1050-27K7	4834	95	4765	93	4737	93	51
ORX-2-WM-16L-1050-27K8	4526	89	4462	87	4435	87	51
ORX-2-WM-16L-1050-30K8	4853	95	4784	94	4755	93	51
ORX-2-WM-16L-1050-30K7	5226	102	5152	101	5121	100	51
ORX-2-WM-16L-1050-35K8	4853	95	4784	94	4755	93	51
ORX-2-WM-16L-1050-40K8	5226	102	5152	101	5121	100	51
ORX-2-WM-16L-1050-40K7	5647	111	5567	109	5534	109	51
ORX-2-WM-16L-1050-50K8	5226	102	5152	101	5121	100	51
ORX-2-WM-16L-1050-50K7	5647	111	5567	109	5534	109	51

Lumen Maintenance Data							
Ambient Temperature	Drive Current	L90 Hours*	L70 Hours**	30,000 Hours*	50,000 Hours*	60,000 Hours*	100,000 Hours**
25°C	Up to 700mA	58,000	173,000	95.7%	91.6%	89.6%	82.1%
	1050mA	48,000	143,000	94.3%	89.5%	87.2%	78.5%

*Reported extrapolations per IESNA TM-21 **Projected extrapolations per IESNA TM-21

LED KELVIN RANGE

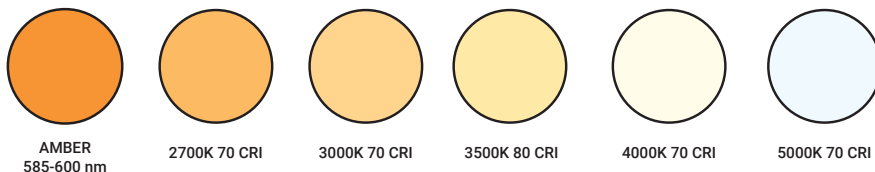

Color	Dominant or Peak Wavelength Range (nm)	
	Minimum	Maximum
Amber	585	600

PRODUCT SPECIFICATIONS

LUMEN CHART

Part Number	T2	LM/W	T3	LM/W	T4	LM/W	WATTS
ORX-2-WM-32L-350-27K7	3223	95	3177	93	3158	93	34
ORX-2-WM-32L-350-27K8	3017	89	2974	87	2957	87	34
ORX-2-WM-32L-350-30K8	3235	95	3189	94	3170	93	34
ORX-2-WM-32L-350-30K7	3484	102	3435	101	3414	100	34
ORX-2-WM-32L-350-35K8	3235	95	3189	94	3170	93	34
ORX-2-WM-32L-350-40K8	3484	102	3435	101	3414	100	34
ORX-2-WM-32L-350-40K7	3765	111	3711	109	3689	109	34
ORX-2-WM-32L-350-50K8	3484	102	3435	101	3414	100	34
ORX-2-WM-32L-350-50K7	3765	111	3711	109	3689	109	34
ORX-2-WM-32L-530-27K7	4880	94	4810	93	4782	92	52
ORX-2-WM-32L-530-27K8	4569	88	4504	87	4477	86	52
ORX-2-WM-32L-530-30K8	4899	94	4829	93	4801	92	52
ORX-2-WM-32L-530-30K7	5276	101	5201	100	5170	99	52
ORX-2-WM-32L-530-35K8	4899	94	4829	93	4801	92	52
ORX-2-WM-32L-530-40K8	5276	101	5201	100	5170	99	52
ORX-2-WM-32L-530-40K7	5701	110	5620	108	5586	107	52
ORX-2-WM-32L-530-50K8	5276	101	5201	100	5170	99	52
ORX-2-WM-32L-530-50K7	5701	110	5620	108	5586	107	52
ORX-2-WM-32L-700-27K7	6445	95	6353	93	6316	93	68
ORX-2-WM-32L-700-27K8	6035	89	5949	87	5914	87	68
ORX-2-WM-32L-700-30K8	6470	95	6378	94	6340	93	68
ORX-2-WM-32L-700-30K7	6968	102	6869	101	6829	100	68
ORX-2-WM-32L-700-35K8	6470	95	6378	94	6340	93	68
ORX-2-WM-32L-700-40K8	6968	102	6869	101	6829	100	68
ORX-2-WM-32L-700-40K7	7529	111	7422	109	7378	109	68
ORX-2-WM-32L-700-50K8	6968	102	6869	101	6829	100	68
ORX-2-WM-32L-700-50K7	7529	111	7422	109	7378	109	68
ORX-2-WM-32L-1050-27K7	9668	95	9530	93	9474	93	102
ORX-2-WM-32L-1050-27K8	9052	89	8923	87	8870	87	102
ORX-2-WM-32L-1050-30K8	9705	95	9567	94	9510	93	102
ORX-2-WM-32L-1050-30K7	10453	102	10304	101	10243	100	102
ORX-2-WM-32L-1050-35K8	9705	95	9567	94	9510	93	102
ORX-2-WM-32L-1050-40K8	10453	102	10304	101	10243	100	102
ORX-2-WM-32L-1050-40K7	11294	111	11133	109	11067	109	102
ORX-2-WM-32L-1050-50K8	10453	102	10304	101	10243	100	102
ORX-2-WM-32L-1050-50K7	11294	111	11133	109	11067	109	102

B.U.G. CHART

Part Number	T2 B.U.G.	T3 B.U.G.	T4 B.U.G.	WATTS
ORX-2-WM-32L-350-27K7	B1-U0-G1	B1-U0-G1	B1-U0-G1	34
ORX-2-WM-32L-350-27K8	B1-U0-G1	B1-U0-G1	B1-U0-G1	34
ORX-2-WM-32L-350-30K8	B1-U0-G1	B1-U0-G1	B1-U0-G1	34
ORX-2-WM-32L-350-30K7	B1-U0-G1	B1-U0-G1	B1-U0-G1	34
ORX-2-WM-32L-350-35K8	B1-U0-G1	B1-U0-G1	B1-U0-G1	34
ORX-2-WM-32L-350-40K8	B1-U0-G1	B1-U0-G1	B1-U0-G1	34
ORX-2-WM-32L-350-40K7	B1-U0-G1	B1-U0-G1	B1-U0-G1	34
ORX-2-WM-32L-350-50K8	B1-U0-G1	B1-U0-G1	B1-U0-G1	34
ORX-2-WM-32L-350-50K7	B1-U0-G1	B1-U0-G1	B1-U0-G1	34
ORX-2-WM-32L-530-27K7	B1-U0-G1	B1-U0-G1	B1-U0-G1	52
ORX-2-WM-32L-530-27K8	B1-U0-G1	B1-U0-G1	B1-U0-G1	52
ORX-2-WM-32L-530-30K8	B1-U0-G1	B1-U0-G1	B1-U0-G1	52
ORX-2-WM-32L-530-30K7	B1-U0-G1	B1-U0-G1	B1-U0-G1	52
ORX-2-WM-32L-530-35K8	B1-U0-G1	B1-U0-G1	B1-U0-G1	52
ORX-2-WM-32L-530-40K8	B1-U0-G1	B1-U0-G1	B1-U0-G1	52
ORX-2-WM-32L-530-40K7	B1-U0-G1	B1-U0-G1	B1-U0-G1	52
ORX-2-WM-32L-530-50K8	B1-U0-G1	B1-U0-G1	B1-U0-G1	52
ORX-2-WM-32L-530-50K7	B1-U0-G1	B1-U0-G1	B1-U0-G1	52
ORX-2-WM-32L-700-27K7	B1-U0-G1	B2-U0-G2	B2-U0-G2	68
ORX-2-WM-32L-700-27K8	B1-U0-G1	B2-U0-G2	B1-U0-G2	68
ORX-2-WM-32L-700-30K8	B1-U0-G1	B2-U0-G2	B2-U0-G2	68
ORX-2-WM-32L-700-30K7	B1-U0-G1	B2-U0-G2	B2-U0-G2	68
ORX-2-WM-32L-700-35K8	B1-U0-G1	B2-U0-G2	B2-U0-G2	68
ORX-2-WM-32L-700-40K8	B1-U0-G1	B2-U0-G2	B2-U0-G2	68
ORX-2-WM-32L-700-40K7	B2-U0-G2	B2-U0-G2	B2-U0-G2	68
ORX-2-WM-32L-700-50K8	B1-U0-G1	B2-U0-G2	B2-U0-G2	68
ORX-2-WM-32L-700-50K7	B2-U0-G2	B2-U0-G2	B2-U0-G2	68
ORX-2-WM-32L-1050-27K7	B2-U0-G2	B2-U0-G2	B2-U0-G2	102
ORX-2-WM-32L-1050-27K8	B2-U0-G2	B2-U0-G2	B2-U0-G2	102
ORX-2-WM-32L-1050-30K8	B2-U0-G2	B2-U0-G2	B2-U0-G2	102
ORX-2-WM-32L-1050-30K7	B2-U0-G2	B2-U0-G2	B2-U0-G2	102
ORX-2-WM-32L-1050-35K8	B2-U0-G2	B2-U0-G2	B2-U0-G2	102
ORX-2-WM-32L-1050-40K8	B2-U0-G2	B2-U0-G2	B2-U0-G2	102
ORX-2-WM-32L-1050-40K7	B2-U0-G2	B2-U0-G2	B2-U0-G2	102
ORX-2-WM-32L-1050-50K8	B2-U0-G2	B2-U0-G2	B2-U0-G2	102
ORX-2-WM-32L-1050-50K7	B2-U0-G2	B2-U0-G2	B2-U0-G2	102



701 Kingshill Place, Carson, CA 90746
 Call Us Today (310) 341-2037

nlsighting.com

PRODUCT SPECIFICATIONS

LUMEN CHART							
Part Number	T2	LM/W	T3	LM/W	T4	LM/W	WATTS
ORX-2-WM-64L-350-27K7	6445	95	6353	93	6316	93	68
ORX-2-WM-64L-350-27K8	6035	89	5949	87	5914	87	68
ORX-2-WM-64L-350-30K8	6470	95	6378	94	6340	93	68
ORX-2-WM-64L-350-30K7	6969	102	6869	101	6829	100	68
ORX-2-WM-64L-350-35K8	6470	95	6378	94	6340	93	68
ORX-2-WM-64L-350-40K8	6969	102	6869	101	6829	100	68
ORX-2-WM-64L-350-40K7	7530	111	7422	109	7378	109	68
ORX-2-WM-64L-350-50K8	6969	102	6869	101	6829	100	68
ORX-2-WM-64L-350-50K7	7530	111	7422	109	7378	109	68
ORX-2-WM-64L-530-27K7	9760	95	9621	93	9564	93	103
ORX-2-WM-64L-530-27K8	9139	89	9008	87	8955	87	103
ORX-2-WM-64L-530-30K8	9798	95	9658	94	9601	93	103
ORX-2-WM-64L-530-30K7	10552	102	10402	101	10341	100	103
ORX-2-WM-64L-530-35K8	9798	95	9658	94	9601	93	103
ORX-2-WM-64L-530-40K8	10552	102	10402	101	10341	100	103
ORX-2-WM-64L-530-40K7	11402	111	11239	109	11173	108	103
ORX-2-WM-64L-530-50K8	10552	102	10402	101	10341	100	103
ORX-2-WM-64L-530-50K7	11402	111	11239	109	11173	108	103
ORX-2-WM-64L-700-27K7	12891	94	12707	93	12632	92	137
ORX-2-WM-64L-700-27K8	12070	88	11898	87	11827	86	137
ORX-2-WM-64L-700-30K8	12941	94	12756	93	12681	93	137
ORX-2-WM-64L-700-30K7	13937	102	13738	100	13657	100	137
ORX-2-WM-64L-700-35K8	12941	94	12756	93	12681	93	137
ORX-2-WM-64L-700-40K8	13937	102	13738	100	13657	100	137
ORX-2-WM-64L-700-40K7	15059	110	14844	108	14757	108	137
ORX-2-WM-64L-700-50K8	13937	102	13738	100	13657	100	137
ORX-2-WM-64L-700-50K7	15059	110	14844	108	14757	108	137
ORX-2-WM-64L-1A-27K7	18415	92	18152	91	18045	90	200
ORX-2-WM-64L-1A-27K8	17243	86	16996	85	16896	84	200
ORX-2-WM-64L-1A-30K8	18487	92	18223	91	18115	91	200
ORX-2-WM-64L-1A-30K7	19910	100	19626	98	19510	98	200
ORX-2-WM-64L-1A-35K8	18487	92	18223	91	18115	91	200
ORX-2-WM-64L-1A-40K8	19910	100	19626	98	19510	98	200
ORX-2-WM-64L-1A-40K7	21513	108	21206	106	21081	105	200
ORX-2-WM-64L-1A-50K8	19910	100	19626	98	19510	98	200
ORX-2-WM-64L-1A-50K7	21513	108	21206	106	21081	105	200

B.U.G. CHART					
Part Number	T2 B.U.G.	T3 B.U.G.	T4 B.U.G.		WATTS
ORX-2-WM-64L-350-27K7	B1-U0-G1	B2-U0-G2	B2-U0-G2		68
ORX-2-WM-64L-350-27K8	B1-U0-G1	B2-U0-G2	B1-U0-G2		68
ORX-2-WM-64L-350-30K8	B1-U0-G1	B2-U0-G2	B2-U0-G2		68
ORX-2-WM-64L-350-30K7	B1-U0-G1	B2-U0-G2	B2-U0-G2		68
ORX-2-WM-64L-350-35K8	B1-U0-G1	B2-U0-G2	B2-U0-G2		68
ORX-2-WM-64L-350-40K8	B1-U0-G1	B2-U0-G2	B2-U0-G2		68
ORX-2-WM-64L-350-40K7	B2-U0-G2	B2-U0-G2	B2-U0-G2		68
ORX-2-WM-64L-350-50K8	B1-U0-G1	B2-U0-G2	B2-U0-G2		68
ORX-2-WM-64L-350-50K7	B2-U0-G2	B2-U0-G2	B2-U0-G2		68
ORX-2-WM-64L-530-27K7	B2-U0-G2	B2-U0-G2	B2-U0-G2		103
ORX-2-WM-64L-530-27K8	B2-U0-G2	B2-U0-G2	B2-U0-G2		103
ORX-2-WM-64L-530-30K8	B2-U0-G2	B2-U0-G2	B2-U0-G2		103
ORX-2-WM-64L-530-30K7	B2-U0-G2	B2-U0-G2	B2-U0-G2		103
ORX-2-WM-64L-530-35K8	B2-U0-G2	B2-U0-G2	B2-U0-G2		103
ORX-2-WM-64L-530-40K8	B2-U0-G2	B2-U0-G2	B2-U0-G2		103
ORX-2-WM-64L-530-40K7	B2-U0-G2	B2-U0-G2	B2-U0-G2		103
ORX-2-WM-64L-530-50K8	B2-U0-G2	B2-U0-G2	B2-U0-G2		103
ORX-2-WM-64L-530-50K7	B2-U0-G2	B2-U0-G2	B2-U0-G2		103
ORX-2-WM-64L-700-27K7	B2-U0-G2	B3-U0-G3	B3-U0-G3		137
ORX-2-WM-64L-700-27K8	B2-U0-G2	B3-U0-G3	B2-U0-G2		137
ORX-2-WM-64L-700-30K8	B2-U0-G2	B3-U0-G3	B3-U0-G3		137
ORX-2-WM-64L-700-30K7	B2-U0-G2	B3-U0-G3	B3-U0-G3		137
ORX-2-WM-64L-700-35K8	B2-U0-G2	B3-U0-G3	B3-U0-G3		137
ORX-2-WM-64L-700-40K8	B2-U0-G2	B3-U0-G3	B3-U0-G3		137
ORX-2-WM-64L-700-40K7	B3-U0-G3	B3-U0-G3	B3-U0-G3		137
ORX-2-WM-64L-700-50K8	B2-U0-G2	B3-U0-G3	B3-U0-G3		137
ORX-2-WM-64L-700-50K7	B3-U0-G3	B3-U0-G3	B3-U0-G3		137
ORX-2-WM-64L-1A-27K7	B3-U0-G3	B3-U0-G3	B3-U0-G3		200
ORX-2-WM-64L-1A-27K8	B3-U0-G3	B3-U0-G3	B3-U0-G3		200
ORX-2-WM-64L-1A-30K8	B3-U0-G3	B3-U0-G3	B3-U0-G3		200
ORX-2-WM-64L-1A-30K7	B3-U0-G3	B3-U0-G3	B3-U0-G3		200
ORX-2-WM-64L-1A-35K8	B3-U0-G3	B3-U0-G3	B3-U0-G3		200
ORX-2-WM-64L-1A-40K8	B3-U0-G3	B3-U0-G3	B3-U0-G3		200
ORX-2-WM-64L-1A-40K7	B3-U0-G3	B3-U0-G3	B3-U0-G3		200
ORX-2-WM-64L-1A-50K8	B3-U0-G3	B3-U0-G3	B3-U0-G3		200
ORX-2-WM-64L-1A-50K7	B3-U0-G3	B3-U0-G3	B3-U0-G3		200



701 Kingshill Place, Carson, CA 90746
 Call Us Today (310) 341-2037

nlsighting.com

PRODUCT SPECIFICATIONS

WALL MOUNT

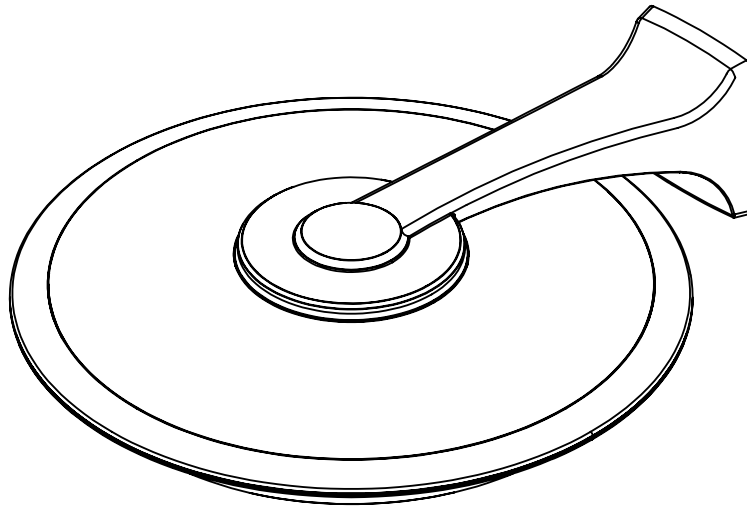
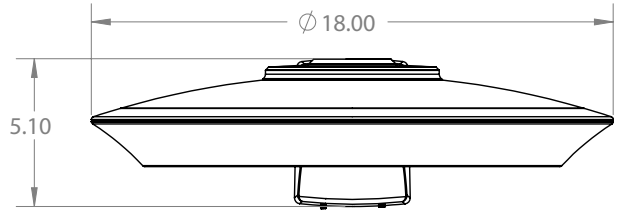
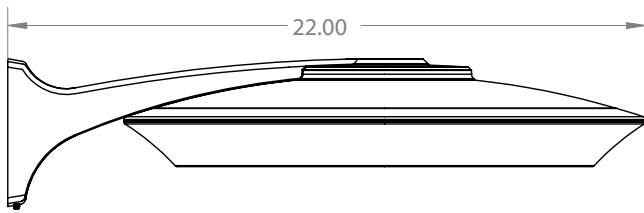

SCAN FOR INSTALLATION INSTRUCTIONS



PRODUCT SPECIFICATIONS

MARINE GRADE FINISH (MGF)

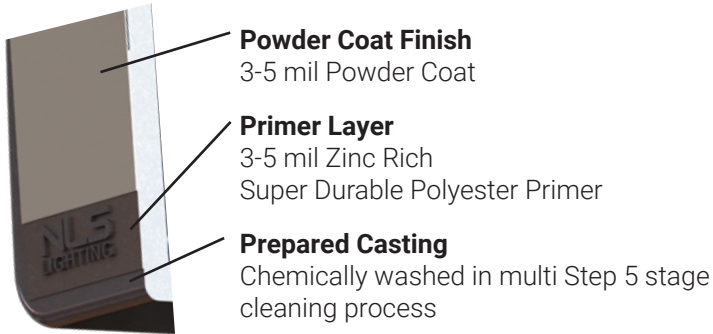

Marine Grade Finish (MGF)

The **(MGF)** is a multi step process. Chemically washed in a 5 stage cleaning system. Pre-baked. Powder coated 3-5 mils of Zinc Rich Super Durable Polyester Primer. Oven Baked. Finished Powder Coating of Super Durable Polyester Powder Coat 3-5 mil thickness.

TAMPER PROOF HARDWARE

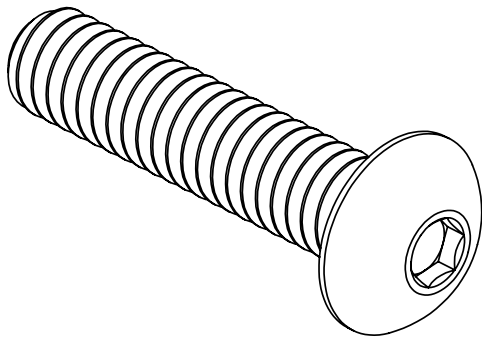

Tamper Proof Hardware (TPH)

316 Stainless Steel Button Head Hex Drive Screws. Provided to protect the optical assembly and the driver compartment for vandal resistance.

HOUSE SIDE SHIELD (HSS)

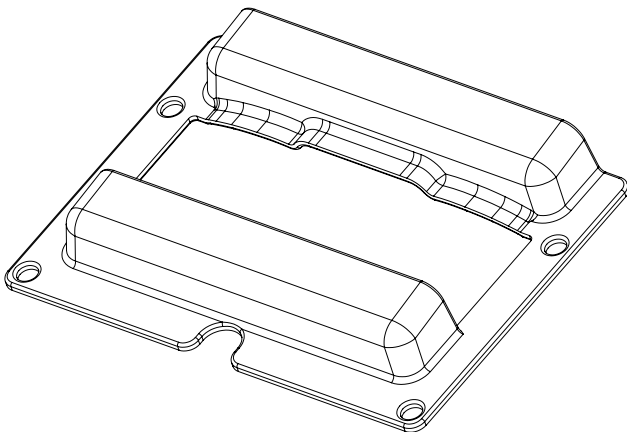

House Side Shield (HSS)

House Side Shield **(HSS)** is designed for stringent property line cutoff. Injection Molded Glass Filled Nylon, standard finish is black.

PRODUCT SPECIFICATIONS

BLACK OPTIC FRAME

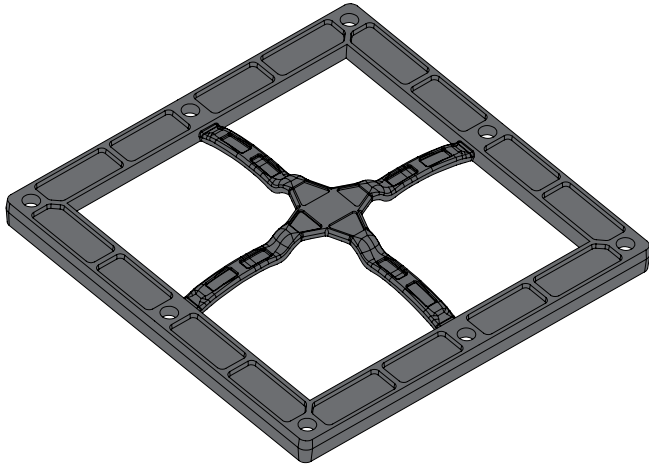

Black Optic Frame (BOF)

Optional Black Optic Frame.

BLACK HARDWARE

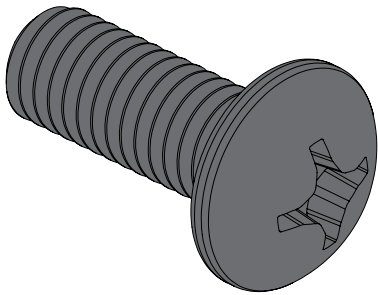

Black Hardware (BH)

Black painted hardware.

PRODUCT SPECIFICATIONS

IES DISTRIBUTIONS

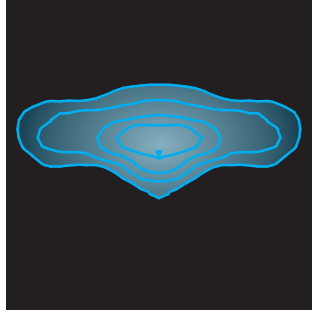
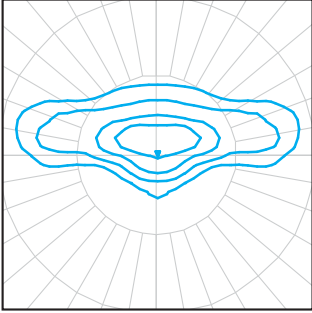

T2 Optic

The Type II distribution is used for narrow pathways and trails, narrow entrances of shopping centers, parking lots and office complex's.

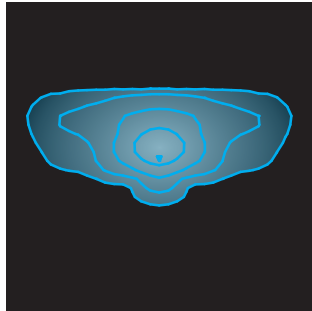
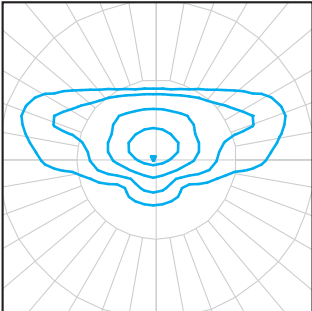

T3 Optic

The type III distribution is meant for roadway lighting, general parking areas and other areas where a larger area of lighting is required. Type III lighting needs to be placed to the side of the area, allowing the light to project outward and fill the area. This produces a filling light flow.

Type III light distributions have a preferred lateral width of 40 degrees. This distribution is intended for luminaires mounted at or near the side of medium width roadways or areas, where the width of the roadway or area does not exceed 2.75 times the mounting height.

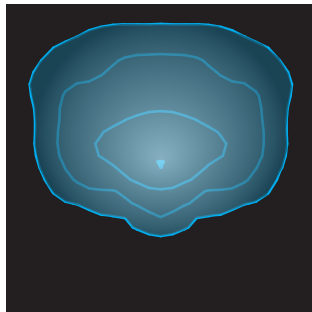
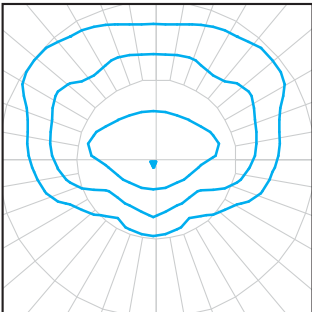

T4 Optic

The type IV distribution produces a semicircular light meant for mounting on the sides of buildings and walls. It's best for illuminating the perimeter of parking areas and businesses. The intensity of the Type IV lighting has the same intensity at angles from 90 degrees to 270 degrees.

Type IV light distributions have a preferred lateral width of 60 degrees. This distribution is intended for side-of-road mounting and is generally used on wide roadways where the roadway width does not exceed 3.7 times the mounting height.

SILICONE OPTICS

NLS Lighting Silicone Micro Optical System technology takes quality and performance to the highest level. Vandal resistant, superior clarity—Micro Optics have become the best and lasting solution in the industry.

BENEFITS

- Produces superior 96% clarity
- Heat resistant to 150° C, 50% higher than acrylic
- Ecologically friendly—no glare
- Vandal-resistant
- Does not brittle, crack, or yellow over time

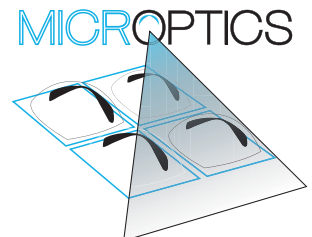

PRODUCT SPECIFICATIONS

FSP-211 WITH MOTION SENSOR (FSP-XX)

- FSP-211 (FSP-X)—Passive infrared (PIR) sensor providing multi-level control based on motion/daylight contribution.
- All control parameters adjustable via wireless configuration remote storing and transmitting sensor profiles.
- FSP-20 mounting heights 9-20 feet
- FSP-40 mounting heights 21-40 feet.
- Includes 5 dimming event cycles, 0-10V dimming with motion sensing, re-programmable in the field.
- FSIR-100 commissioning remote is required to change sensor settings. Please contact factory for ordering.

FSP-211

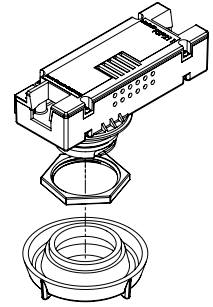

FSP-20

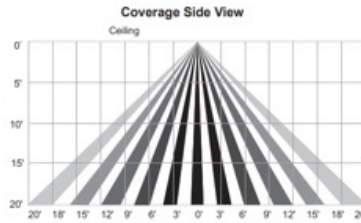
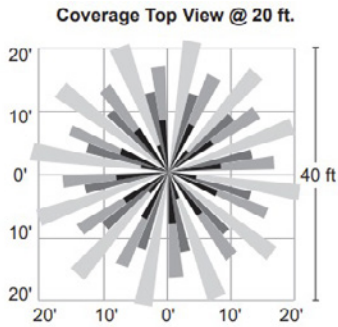

FSP-40

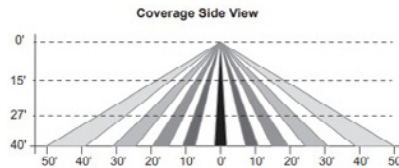
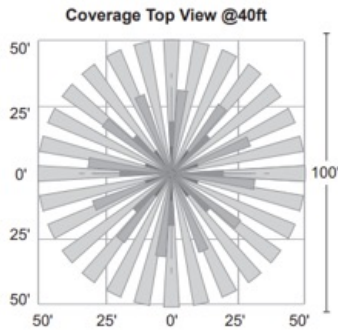

Sensor Specification

