



LED WATTAGE CHART

	16L	32L	48L	64L	80L
350 milliamps	-	33w	51w	66w	-
400 milliamps	21w	-	-	-	-
530 milliamps	28w	54w	80w	102w	-
700 milliamps	36w	71w	104w	137w	-
1050 milliamps	56w	106w	156w	205w	247w

The modern Nova 2, Dark Sky friendly full cutoff LED post top luminaire utilizes NLS' patented *Star Power* Optical System and Silicone Optics to distribute light evenly. The Nova 2 utilizes the most advanced LED technology with the highest lumen per watt LEDs in the market place. Available Kelvin temperatures of Amber, 2700K, 3000K, 3500K, 4000K and 5000K.

The Nova 2 offers a collar design that makes the perfect complement to any retail, high-end commercial project, government icon, theater, or walkway project. Wattage offerings begin from 21 to 247. The standard warranty is five year for LEDs and drivers.

BUY AMERICAN

To ensure the latest BAA/TAA/BABA Standards are being met, please select BAA, TAA, or BABA in the options section. Please contact the factory before placing an order for any NLS products requesting BAA (Buy American Act), TAA (Trade American Act), or BABA (Build America, Buy America).



STAR POWER™ OPTICAL SYSTEM

The Star Power™ reflector is an excellent system which provides great value and performance. Star Power Patent number: 10168023

Project Name:

Type:

NOVA 2 ORDERING GUIDE

Cat#	Light Dist.	# of LEDs	Milliamps	Kelvin	Volts
Nova 2 (NOV-2)	Type 2 (T2)	16 (16L)	350 (35) ②	Amber 586-600nm (AMBER) ③ ④ ⑤	120-277 (UNV)
	Type 3 (T3)	32 (32L)	400 (40)	2700K, 70 CRI (27K7)	347-480 (HV)
	Type 4 (T4)	48 (48L)	530 (53)	2700K, 80 CRI (27K8) ①	
	Type 5 (T5)	64 (64L)	700 (7)	3000K, 70 CRI (30K7)	
		80 (80L) ③	1050 (1)	3000K, 80 CRI (30K8) ①	
				3500K, 80 CRI (35K8) ①	
				4000K, 70 CRI (40K7)	
				4000K, 80 CRI (40K8) ①	
				5000K, 70 CRI (50K7)	
				5000K, 80 CRI (50K8) ①	

Mounting	Color	Controls Options	Options
Post Top Over 2-3/8" OD (PT238)	Bronze Textured (BRZ)	Nema 7-Pin Receptacle (PE7)	Marine Grade Finish (MGF)
Post Top Over 3" OD (PT3)	White Textured (WHT)	Photocell + Receptacle (PCR)	Buy American Act (BAA) ⑥
	Smooth White Gloss (SWT)	Receptacle + Shorting Cap (PER)	Trade Agreement Act (TAA) ⑥
	Silver Metallic (SVR)	Custom Controls Integration (CCI) ④	Build America Buy American (BABA) ⑥
	Black Textured (BLK)	Button Type Photocell (PC) ②	
	Smooth Black Gloss (SBK)	FSP-211 with Motion Sensor <i>8' + Below Heights</i> (FSP-8) ②	
	Graphite Textured (GPH)	<i>9'-20' Heights</i> (FSP-20) ②	
	Grey Textured (GRY)	<i>21'-40' Heights</i> (FSP-40) ②	
	Green Textured (GRN)		
	Hunter Green Textured (HGN)		
	Custom (CS)		

Notes:

- ① Consult Factory for Lead Time. Consult Factory for 90 CRI Requests.
- ② Universal Voltage 120-277
- ③ Only available in 1050mA with Silicone Optics
- ④ Please contact Factory for Custom Control Integration requests (nLight, NX, WaveLinx, Crestron, DMX/RDM, Synapse, Casambi, Dali II, Avi-On, or other control systems)
- ⑤ Turtle Safe
- ⑥ Consult factory for all BAA/TAA/BABA requests
- ⑦ 350mA not available in 16L
- ⑧ Consult Factory for Lead Time
- ⑨ Not Available above 1000mA



701 Kingshill Place, Carson, CA 90746
Call Us Today (310) 341-2037

nslighting.com

PRODUCT SPECIFICATIONS

HOUSING

Low Profile Cast and Spun Aluminum Housing and Frame.

ELECTRICAL

- 120-277 Volts (UNV) or 347-480 Volts (HV)
- 0-10V dimming driver
- Driver power factor at maximum load is $\geq .95$, THD maximum load is 15%
- LED Drivers Ambient Temp. Min is -40°C and Ambient Temp. Max ranges from 50°C to 55°C and, in some cases, even higher. Consult the factory for revalidation by providing the fixture catalog string before quoting and specifying it.
- All internal wiring UL certified for 600 VAC and 105°C
- CRI 70, 80 or 90
- Color temperatures: Amber, 2700K, 3000K, 3500K, 4000K, 5000K
- Surge Protection: 20KA supplies as standard.

OPTIONS

- MARINE GRADE FINISH (MGF)—A multi-step process creating protective finishing coat against harsh environments.
 - Chemically washed in a 5 stage cleaning system.
 - Pre-baked
 - Powder coated 3-5 mils of Zinc Rich Super Durable Polyester Primer.
 - 1-2 feet inside pole coverage top and bottom.
 - Oven Baked.
 - Finished Powder Coating of Super Durable Polyester Powder Coat 3-5 mil thickness.

CONTROLS

- FSP-211 (FSP-X)—Passive infrared (PIR) sensor providing multi-level control based on motion/daylight contribution.
 - All control parameters adjustable via wireless configuration remote storing and transmitting sensor profiles.
 - FSP-20 mounting heights 9-20 feet
 - FSP-40 mounting heights 21-40 feet.
 - Includes 5 dimming event cycles, 0-10V dimming with motion sensing, re-programmable in the field.
 - FSIR-100 commissioning remote is required to change sensor settings. Please contact factory for ordering.
- NEMA 7-PIN RECEPTACLE (PE7)—An ANSI C136.41-2013 receptacle provides electrical and mechanical interconnection between photo control cell and luminaire. Dimming receptacle available two or four dimming contacts supports 0-10 VDC dimming methods or Digital Addressable Lighting Interface (DALI), providing reliable power interconnect.
- PHOTOCELL + RECEPTACLE (PCR)—7-Pin Receptacle and Electronic Twist Lock Photocell for dusk to dawn operation.
- RECEPTACLE + SHORTING CAP (PER)—7-Pin Receptacle and Shorting Cap.
- PHOTOCELL - Button type photocell.
- Controls Agnostic: Please contact factory for your preferred controls option. (nLight, NX, WaveLinx, Crestron, DMX/RDM, Synapse, Casambi, DALI II, Avi-On, or other control systems)

FINISH

5 mils Powder Coat

OPTICS

Star Power T2, T3, T4 and T5
Silicone Optics; Type 2, 3, 4 and 5

- IES Types

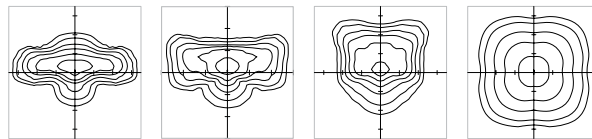

TYPE II (T2)

TYPE III (T3)

TYPE IV (T4)

TYPE V (T5)

WARRANTY

Standard Warranty is 5 years for Driver and LEDs

LISTINGS

UL 1598 Listed

BUY AMERICAN OPTION

While all of the NLS Lighting products listed in this document qualify for the Buy America(n) Act of 1933, we reserve the right to change our listings without notice.

The information provided above is for general informational purposes only. We encourage you to consult legal professionals for advice particular to your projects concerning BAA, TAA, BABA or Buy America.

Additional NLS Products that meet BAA, TAA standards can be found at the following link:

<https://nlsighting.com/buy-american/>



701 Kingshill Place, Carson, CA 90746
Call Us Today (310) 341-2037

nlsighting.com

PRODUCT SPECIFICATIONS

NOVA 2 - LUMEN DATA CHART

PART NUMBER	T2 OPTIC	Lm/W	T3 OPTIC	Lm/W	T4 OPTIC	Lm/W	T5 OPTIC	Lm/W	WATTS
NOV-2-16L-40-27K7	1919	91	1954	93	2007	96	1937	92	21
NOV-2-16L-40-27K8	1797	86	1830	87	1880	90	1814	86	21
NOV-2-16L-40-30K8	1927	92	1962	93	2015	96	1945	93	21
NOV-2-16L-40-30K7	2075	99	2113	101	2170	103	2094	100	21
NOV-2-16L-40-35K8	1927	92	1962	93	2015	96	1945	93	21
NOV-2-16L-40-40K8	2075	99	2113	101	2170	103	2094	100	21
NOV-2-16L-40-40K7	2242	107	2283	109	2345	112	2263	108	21
NOV-2-16L-40-50K8	2075	99	2113	101	2170	103	2094	100	21
NOV-2-16L-40-50K7	2242	107	2283	109	2345	112	2263	108	21
NOV-2-16L-53-30K7	2828	101	2884	103	2968	106	2688	96	28
NOV-2-16L-53-40K7	2940	105	2996	107	3080	110	2800	100	28
NOV-2-16L-53-50K7	3052	109	3108	111	3192	114	2912	104	28
NOV-2-16L-7-30K7	3636	101	3708	103	3816	106	3456	96	36
NOV-2-16L-7-40K7	3780	105	3852	107	3960	110	3600	100	36
NOV-2-16L-7-50K7	3924	109	3996	111	4104	114	3744	104	36
NOV-2-16L-1-30K7	5656	101	5768	103	5936	106	5376	96	56
NOV-2-16L-1-40K7	5880	105	5992	107	6160	110	5600	100	56
NOV-2-16L-1-50K7	6104	109	6216	111	6384	114	5824	104	56
NOV-2-32L-35-30K7	3333	101	3399	103	3498	106	3168	96	33
NOV-2-32L-35-40K7	3465	105	3531	107	3630	110	3300	100	33
NOV-2-32L-35-50K7	3597	109	3663	111	3762	114	3432	104	33
NOV-2-32L-53-30K7	5454	101	5562	103	5724	106	5184	96	54
NOV-2-32L-53-40K7	5670	105	5778	107	5940	110	5755	100	54
NOV-2-32L-53-50K7	5886	109	5994	111	6156	114	5616	104	54
NOV-2-32L-7-30K7	7171	101	7313	103	7526	106	6816	96	71
NOV-2-32L-7-40K7	7455	105	7597	107	7810	110	7100	100	71
NOV-2-32L-7-50K7	7739	109	7881	111	8094	114	7384	104	71
NOV-2-32L-1-30K7	10706	101	10918	103	11236	106	10176	96	106
NOV-2-32L-1-40K7	11130	105	11342	107	11660	110	10600	100	106
NOV-2-32L-1-50K7	11554	109	11766	111	12084	114	11024	104	106
NOV-2-48L-35-30K7	5151	101	5253	103	5406	106	4896	96	51
NOV-2-48L-35-40K7	5355	105	5457	107	5610	110	5100	100	51
NOV-2-48L-35-50K7	5559	109	5661	111	5814	114	5304	104	51
NOV-2-48L-53-30K7	8080	101	8240	103	8480	106	7680	96	80
NOV-2-48L-53-40K7	8400	105	8560	107	8800	110	8000	100	80
NOV-2-48L-53-50K7	8720	109	8880	111	9120	114	8320	104	80
NOV-2-48L-7-30K7	10504	101	10712	103	11024	106	9984	96	104
NOV-2-48L-7-40K7	10920	105	11128	107	11440	110	10400	100	104
NOV-2-48L-7-50K7	11336	109	11544	111	11856	114	10816	104	104
NOV-2-48L-1-30K7	15756	101	16068	103	16536	106	14976	96	156
NOV-2-48L-1-40K7	16380	105	16692	107	17160	110	15600	100	156
NOV-2-48L-1-50K7	17004	109	17316	111	17784	114	16224	104	156
NOV-2-64L-35-30K7	6666	101	6798	103	6996	106	6336	96	66
NOV-2-64L-35-40K7	6930	105	7062	107	7260	110	6600	100	66
NOV-2-64L-35-50K7	7194	109	7326	111	7524	114	6864	104	66
NOV-2-64L-53-30K7	10302	101	10506	103	10812	106	9792	96	102
NOV-2-64L-53-40K7	10710	105	10914	107	11220	110	10200	100	102
NOV-2-64L-53-50K7	11118	109	11322	111	11628	114	10608	104	102
NOV-2-64L-7-30K7	13837	101	14111	103	14522	106	13152	96	137
NOV-2-64L-7-40K7	14385	105	14659	107	15070	110	13700	100	137
NOV-2-64L-7-50K7	14933	109	15207	111	15618	114	14248	104	137
NOV-2-64L-1-30K7	20705	101	21115	103	21730	106	19680	96	205
NOV-2-64L-1-40K7	21525	105	21935	107	22550	110	20500	100	205
NOV-2-64L-1-50K7	22345	109	22755	111	23370	114	21320	104	205
NOV-2-80L-1-30K7	25,426	103	25,535	103	25,209	102	25731	104.2	247
NOV-2-80L-1-40K7	27,472	111	27,590	112	27,237	110	27801	112.6	247
NOV-2-80L-1-50K7	27,472	111	27,590	112	27,237	110	27801	112.6	247

Lumen Maintenance Data

Ambient Temperature	Drive Current	L90 Hours*	L70 Hours**	30,000 Hours*	50,000 Hours*	60,000 Hours*	100,000 Hours**
25°C	Up to 700mA	58,000	173,000	95.7%	91.6%	89.6%	82.1%
	1050mA	38,000	96,000	93.0%	85.4%	81.8%	68.8%

*Reported extrapolations per IESNA TM-21

**Projected extrapolations per IESNA TM-21



701 Kingshill Place, Carson, CA 90746
Call Us Today (310) 341-2037

nlsighting.com

PRODUCT SPECIFICATIONS

DIMENSION	NOV-2
A	21 in.
B	24 in. OD
C	8 in.
Weight	26 lbs.

EPA	Nova 2
Single	.58

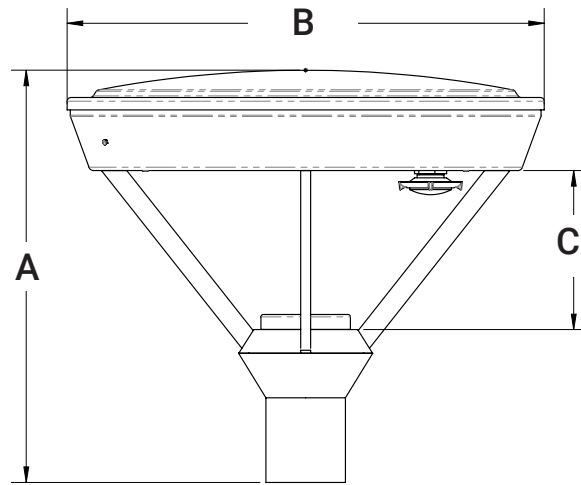

LED KELVIN RANGE

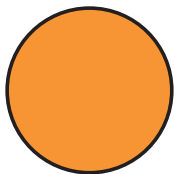

AMBER
585-600 nm

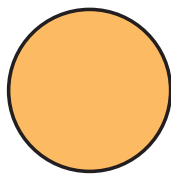

2700K 70 CRI

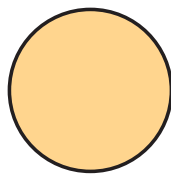

3000K 70 CRI

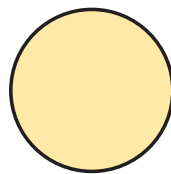

3500K 80 CRI

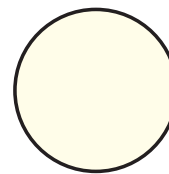

4000K 70 CRI

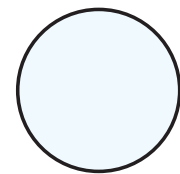

5000K 70 CRI

Color	Dominant or Peak Wavelength Range (nm)	
	Minimum	Maximum
Amber	585	600