

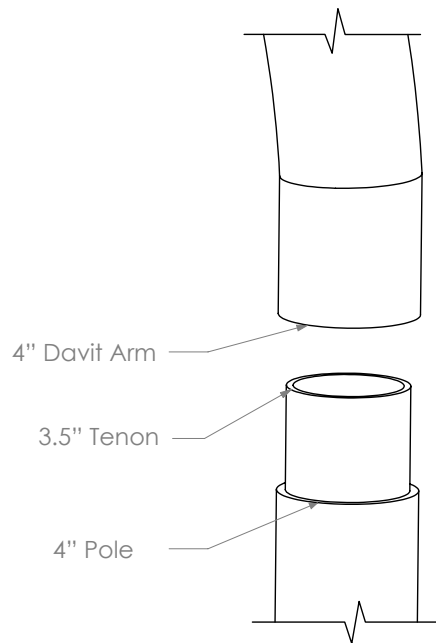

Davit arms are easy to install and made from 4" diameter 11 gauge steel and powder-coated with a thickness of 3-5 mil. Davit arm slips over pole top/tenon or davit fitter of 3 1/2".



Davit fitters are Twin or Quad format and designed to slip over a 3.5" or 4" diameter tenon or pole top. Fitters are powder-coated with a thickness of 3-5 mil.



Project Name:

Type:

DAVIT ARM / FITTER ORDERING GUIDE

Cat#	Mounting	Pole Diameter	Color
Davit Arm (DAV) ❶	Single (0)	3 1/2" OD (312R)	Bronze Textured (BRZ)
	Davit Fitter Twin (DA-TWIN) ❷❸	4" (4R)	White Textured (WHT)
			Smooth White Gloss (SWT)
	Davit Fitter Quad (DA-QUAD) ❷❸		Silver Metallic (SVR)
			Black Textured (BLK)
			Smooth Black Gloss (SBK)
			Graphite Textured (GPH)
			Grey Textured (GRY)
			Green Textured (GRN)
			Hunter Green Textured (HGN)
			Custom (CS)

Notes:

- ❶ Fits over 3 1/2" Tenon
- ❷ Angle configuration is field adjustable
- ❸ Davit Fitter is a standard 3 1/2". Order 312R Arm if you are using a Davit Fitter.



701 Kingshill Place, Carson, CA 90746
Call Us Today (310) 341-2037

nslighting.com

PRODUCT SPECIFICATIONS

DIMENSIONS

EPA

MODEL	SGL	D70	D90	D180	Q70	Q90
DAV	.78	1.60	1.58	1.93	2.50	2.33

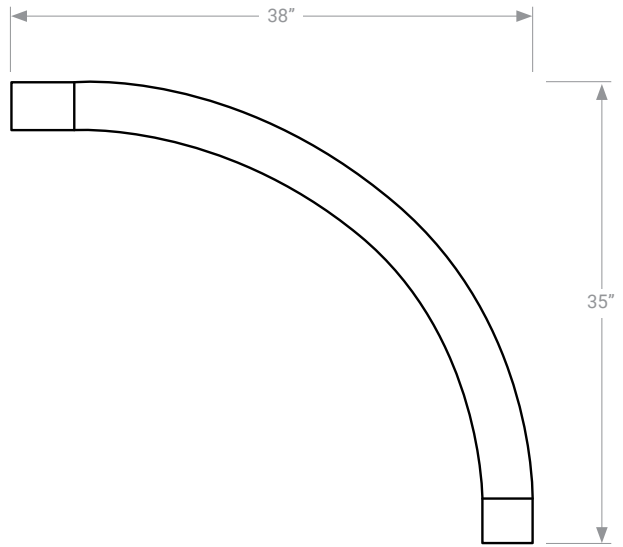

WEIGHT (lbs)

DAV	SGL	D70	D90	D180	Q70	Q90
STEEL	26.8	101.1	101.1	101.1	159.7	159.7
ALUMINUM	9.2	34.7	34.7	34.7	54.8	54.8

DAVIT FITTER TWIN (DA-TWIN)

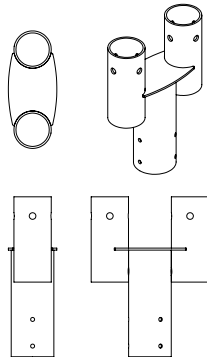

WEIGHT	17 lbs
---------------	--------

DAVIT FITTER QUAD (DA-QUAD)

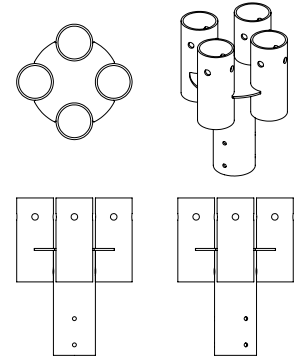
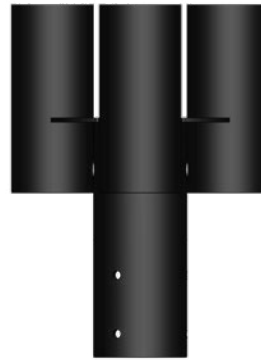

WEIGHT	27 lbs
---------------	--------

DAVIT FITTER CONFIGURATIONS

